

Since 1976

**KOCOM**

# 2016 PRODUCTS CATALOGUE

Home Network System | Home Automation System |  
Videophone System | Door Camera | Digital Doorlock |  
Sub Device | Interphone System

[www.kocomhome.com](http://www.kocomhome.com)

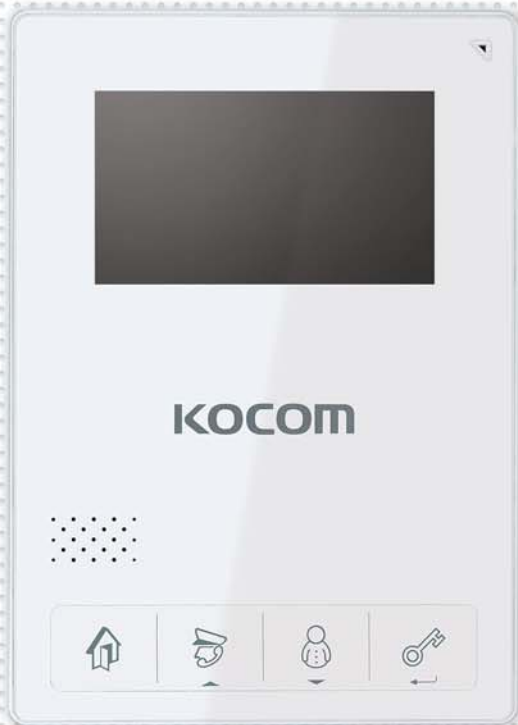

**KOCOM** walks together with  
you to the life you are **Dreaming.**









**02136058926**  
**09121894870**



# CONTENTS

---

 Home Network System	09	Wall Pad
	11	Lobbyphone
	11	Guard Station
<hr/>		
 Home Automation System	13	Videophone
	15	Interphone
	15	Lobbyphone
	16	Guard Station
	16	Integrated Access Device
<hr/>		
 Videophone System	18	Security Videophone
	19	SD Card Videophone
	20	6 Bus Type Videophone
	22	4 Bus Type Videophone
	26	EV Series Videophone
	27	2 wire Non-Polarity Videophone
	28	K6B Videophone System
<hr/>		
 Door Camera	32	4 Wire Multi Entry Panel Camera
	33	2 Wire Multi Entry Panel Camera
	34	4 Wire Door Camera
	36	2 Wire Door Camera
<hr/>		
 Digital Doorlock	38	Digital Doorlock
	40	Sub Digital Doorlock
	41	Access Control System
<hr/>		
 Sub Device	43	Flush Type TV Phone / Sub Videophone
	44	Kitchen TV Phone / Bathroom Phone
	45	Black Box / Curtain
	46	Emergency Switch / Lighting Switch
	47	Security Sensor
	48	Intergrated Access Device
	49	Distributor
<hr/>		
 Interphone System	51	Bus Type Multi Audio Doorphone System
	52	Duplex Interphone & Doorphone
	53	Audio Doorphone
	54	Audio Outdoor Panel
	55	Multi Audio Doorphone System
	56	Multiple Interphone & Doorphone
	58	Duplex Interphone
	59	Intercom
	60	ASTRO Interphone



# HISTORY

[www.kocomhome.com](http://www.kocomhome.com)



## Foundation History

- 1976. 06 Established Korea Telecommunication
- 1980. 03 Incorporated Korea Teldcommunication Co., Ltd.
- 1992. 05 Established technical research institute
- 1995. 04 Listed as one of 100 prospective SMBs
- 1995. 10 Obtained the permit for General Construction Work, Class 1
- 1997. 01 Involved in IMT-2000 Technology & Development business with Electronics and Telecommunication Research Institute
- 1997. 09 Listed in KOSDAQ(A15710)
- 1999. 01 Designated as a company with excellent competition in technology(No TEC99-240)
- 2000. 03 Selected as Top company in Industrial Safety & Health Management(Min. of Labor)
- 2001. 04 Ranked in A grade at KBP Corporate Financial Reliability Evaluation(Ranked third among KOSDAQ-listed companies)
- 2001. 06 Permitted as Special Communication Business (by Min. of Information & Communication)

## Achievement

- 2002. 02 Exported RFID/USN Type home network system(Japan)
- 2004. 08 Nominated as INNO-BIZ company(SMBA)
- 2005. 01 Developed three-colored-LED Mood Lighting fixture requested by Japanese company
- 2006. 05 World first class products selection Selection by Ministry of Commerce
- 2007. 01 Developed three-colored-LED Lighting fixture for a Home Theater requested by Japanese company
- 2008. 05 Awarded a letter of commendation from Ministry of Knowledge Economy
- 2008. 07 Selected as the Grand Prize for Premium Brand in 2008
- 2008. 12 Registered as a supplier to provide the public organization with LED lighting fixtures
- 2009. 05 Releasing 5 LED lights and applying for 3 patents Participating in LED EXPO(Launching LumiONE)
- 2009. 08 Applying for 16 domestic & foreign patents
- 2009. 09 Releasing new items(LINE BAR, MR16 5W)
- 2009. 10 Applying for 8 domestic & foreign patents
- 2009. 12 Exported LED lighting product to Japanese company Releasing new items(PAR20, PAR30, BULB, DOWN LIGHT)



[www.kocomhome.com](http://www.kocomhome.com)



### Global Achievement

- 2010. 06 Won "Bronze Tower" Industrial Award
- 2010. 07 Acquired a High-efficiency certification for LED lighting(MR16)
- 2010. 08 Acquired a High-efficiency certification for LED lighting(PAR30)
- 2010. 09 Acquired a High-efficiency certification for LED lighting(BULB, PAR20)
- 2010. 11 Acquired a patent on LED lighting fixtures
- 2010. 12 Registered as an energy-efficient specializing company
- 2011. 04 Acquired the certification in high-efficiency equipment(D/L)
- 2011. 05 Acquired patent on LED lighting fixtures  
Acquired KS certification(KS C 7651, KS C 7652)
- 2011. 07 Obtained a High-Efficiency certification for LED lighting(MR16)
- 2011. 08 Obtained a High-Efficiency certification for LED lighting(FLAT)
- 2011. 09 Obtained a High-Efficiency certification for LED lighting(FLAT)
- 2011. 10 Obtained a High-Efficiency certification for LED lighting(BULB, FLAT)
- 2011. 11 Obtained a High-Efficiency certification for LED lighting(BULB)
- 2011. 12 Acquired KS certification(KS C 7653)

### Global Ubiquitous Leader

- 2012. 07 Obtained a High-Efficiency certification for LED lighting(BULB)
- 2012. 08 Obtained a High-Efficiency certification for LED lighting(BULB, FLAT)
- 2012. 10 Obtained a High-Efficiency certification for LED lighting(FLAT)
- 2012. 11 Transferred to new headquarter
- 2013. 01 Obtained a High-Efficiency certification for LED lighting(TUBE, Street Light & Security Light)  
Acquired a patent for LED lighting fixtures in a line-bar of a dual spreading structure
- 2013. 02 Applied for six patents(Virtual input device and input method in Home Network)
- 2013. 03 Acquired a patent on a bar Type of LED lighting fixture  
Won yearly design award in LED lamp
- 2013. 04 Acquired a patent on LED lighting fixture in a horizontal bar
- 2013. 05 Obtained a High-Efficiency certification for LED lighting
- 2013. 09 Awarded Grand Prize of 2013 chosen by a customer in brand(LumiONE, Homemanager)
- 2013. 11 Acquired a patent on power-saving system by user identification
- 2014. 05 Awarded Grand Prize of 2014 for customer cherished company in brand(LumiONE, Homemanager)
- 2014. 08 Received a ministerial citation for being nominated as a futuristically creative company in 2nd ceremony





Home Network

# Home Network System

KOCOM's Home Network system is a brand-new solution designed to draw a blueprint of an information community, which interlocks a variety of domestic electronic devices by Wire & Wireless network regardless of a place and time, and this would be the futuristic technology KOCOM exclusively has to improve the quality of people's life.

[www.kocomhome.com](http://www.kocomhome.com)



## Home Control

- **Control on Mobile**  
Gas, Fire, Burglar Alarm Auto Report
- **Household Appliances Control**  
Wall-pad or Mobile Phone
- **Usage inspection by remote control**  
Power, Water, Gas, Hot water, Room temperature, etc.
- **Living Control**  
Light, Curtain, Heat, Gas valve



Control on Mobile



Household Appliances Control



Lighting

## Home Security

- **Security - Emergency Informing System**  
Monitoring an intruder and a fire, Auto Calling System(ACS)
- **Door Remote Control**  
The remote control of a lobby and a door of a household
- **Visitor Auto-Saving System**  
Saves the video information of a visitor during one's absence
- **Remote Monitoring**  
It is possible to monitor remotely subsidiary facilities inside of an apartment complex from guardroom or on mobile
- **Intruder System**  
Acceptance and Dispatch of a parcel
- **Parking Control System**  
Automatic alarm system for in/outgoing of a vehicle



Remote Monitoring



Security



Unmanned System



Parking

## Home Entertainment

- **Wired/Wireless Network**  
Easy transferring, saving and sharing of mass storage data
- **Digital TV System**  
HD(High Definition) broadcasting and watching a film via HDTV and PC
- **Remote Health System**  
Remote Health Care
- **Unmanned Delivery**  
Acceptance and Dispatch of a parcel



Digital TV System



Unmanned Delivery



Wired / Wireless Network



Remote Health Care

Home Network



Home Automation



Videophone



Door Camera



Digital Doorlock



Sub Device



Interphone



www.kocomhome.com

Home Network (All-IP) System Diagram

House Unit

Shared Devices

Complex Network

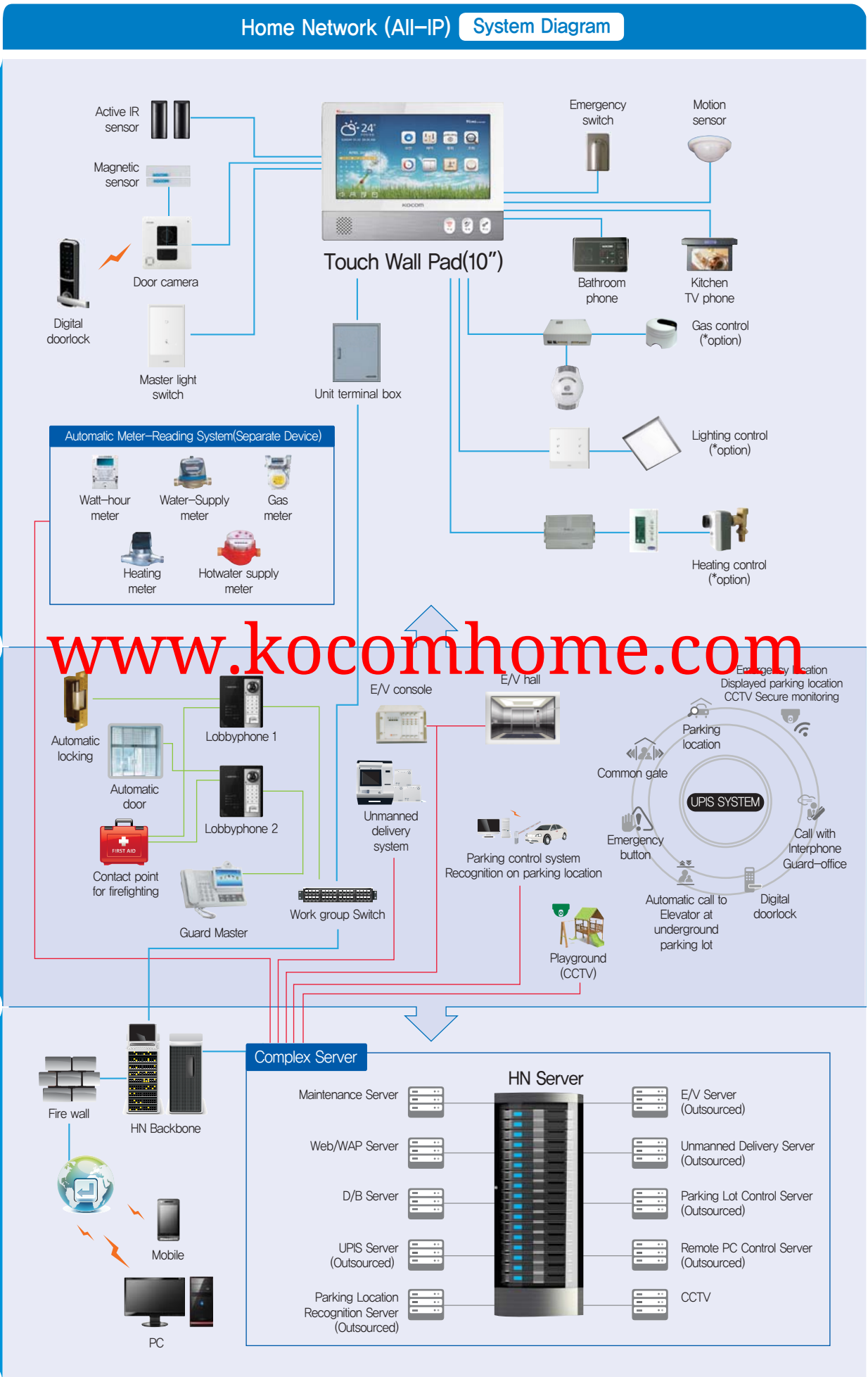



# Wall Pad

## KHN-580



### Function

- Visitor identify & Communication with lobbyphone
- Door open
- Mutual video communication between units/guards
- Telephone function
- Sub devices available (\*option)

### Specification

Display	10.2" TFT LCD, Wide Type
Installation	Flush Type
Speak Mode	Hands-free(speaker phone)
Wiring	Camera(4 Wire), Sub device interlock(8 Wire), Videophone(8 Wire)
Power	AC 100-240V, 50/60Hz
Surface Size	264(W) x 221(H) x 17(D)mm
Buried Size	202(W) x 166(H) x 30(D)mm

### Option

- Kitchen TV Videophone and Bathroom Phone
- Stores visitor image (up to 32 pcs)
- Gas, Sensor 1 (Magnetic sensor), Sensor 2 (Motion or IR sensor)
- Automatic Notification Function in an emergency situation inside a house unit (by SMS)
- Controlling Gas valve, Lighting and Heater

## KHT-590



### Function

- Visitor identify & Communication with lobbyphone
- Door open
- Mutual video communication between units/guards
- Telephone function
- Sub devices available (\*option)

### Specification

Display	10.2" TFT LCD, Wide Type
Installation	Flush Type
Speak Mode	Hands-free(speaker phone)
Wiring	Camera(4 Wire), Sub device interlock(8 Wire), Videophone(8 Wire)
Power	AC 100-240V, 50/60Hz
Surface Size	264(W) x 221(H) x 17(D)mm
Buried Size	202(W) x 166(H) x 30(D)mm

### Option

- Kitchen TV Videophone and Bathroom Phone
- Stores visitor image (up to 32 pcs)
- Gas, Sensor 1 (Magnetic sensor), Sensor 2 (Motion or IR sensor)
- Automatic Notification Function in an emergency situation inside a house unit (by SMS)
- Controlling Gas valve, Lighting and Heater

## KHN-893



### Function

- Visitor identify & Communication with lobbyphone
- Door open
- Mutual video communication between units/guards
- Telephone function
- Sub devices available (\*option)

### Specification

Display	10.2" TFT LCD, Wide Type
Installation	Flush Type
Speak Mode	Hands-free(speaker phone)
Wiring	Camera(4 Wire), Sub device interlock(8 Wire), Videophone(8 Wire)
Power	AC 100-240V, 50/60Hz
Surface Size	316(W) x 214(H) x 17.5(D)mm
Buried Size	238(W) x 167(H) x 37(D)mm

### Option

- Kitchen TV Videophone and Bathroom Phone
- Stores visitor image (up to 32 pcs)
- Gas, Sensor 1 (Magnetic sensor), Sensor 2 (Motion or IR sensor)
- Automatic Notification Function in an emergency situation inside a house unit (by SMS)
- Controlling Gas valve, Lighting and Heater

www.kocomhome.com

Home Network

Home Automation

Videophone

Door Camera

Digital Doorlock

Sub Device

Interphone

# Wall Pad

## KHN-983



### Function

- Visitor identify & Communication with lobbyphone
- Door open
- Mutual video communication between units/guards
- Telephone function
- Sub devices available (\*option)

### Specification

Display	10.2" TFT LCD, Wide Type
Installation	Flush Type
Speak Mode	Hands-free(speaker phone)
Wiring	Camera(4 Wire), Sub device interlock(8 Wire), Videophone(8 Wire)
Power	AC 100-240V, 50/60Hz
Surface Size	348(W) x 213(H) x 18(D)mm
Buried Size	252(W) x 166(H) x 36(D)mm

### Option

- Kitchen TV Videophone and Bathroom Phone
- Stores visitor image (up to 32 pcs)
- Gas, Sensor 1 (Magnetic sensor), Sensor 2 (Motion or IR sensor)
- Automatic Notification Function in an emergency situation inside a house unit (by SMS)
- Controlling Gas Valve, Lighting and Heater

[www.kocomhome.com](http://www.kocomhome.com)

## KHN-783 / KHN-773



### Function

- Visitor identify & Communication with lobbyphone
- Door open
- Mutual video communication between units/guards
- Telephone function
- Sub devices available (\*option)
- Home Control (ARS) (Lighting, Gas, A/C, Heater)
- Automatic alert function

### Specification

Display	- KHN-783 : 10.2" TFT LCD - KHN-773 : 7" TFT LCD
Installation	Flush Type
Speak Mode	Hands-free(speaker phone)
Wiring	Camera(4 Wire), Sub device interlock(8 Wire), Videophone(8 Wire)
Power	AC 100-240V, 50/60Hz
Surface Size	- KHN-783 : 347(W) x 212(H) x 18.5(D)mm - KHN-773 : 280(W) x 184(H) x 18.5(D)mm
Buried Size	225(W) x 155(H) x 53(D)mm

### Option

- Kitchen TV Videophone and Bathroom Phone available
- Stores visitor image (up to 32 pcs)
- Gas, Sensor 1 (Magnetic sensor), Sensor 2 (Motion or IR sensor)
- Automatic Notification Function in an emergency situation inside a house unit (by SMS)
- Controlling Gas valve, Lighting and Heater



# Common Gate Lobbyphone

## KLP-631



### Function

- One-way video call with residents
- Door open with password or RF-card (13.56MHz)
- LCD status display

### Specification

Installation	Flush Type
Speak Mode	Hands-free
Wiring	UTPCat 5.e / 4P
Power	DC 24V
Surface Size	248(W) x 296(H) x 18,5(D)mm
Buried Size	183(W) x 225(H) x 40(D)mm
Buried Box	KJB-800

## KLP-300R2



### Function

- One-way video call with residents
- Door open with password or RF-card (13.56MHz)

### Specification

Installation	Flush Type
Speak Mode	Hands-free
Wiring	UTPCat 5.e / 4P
Power	DC 24V
Surface Size	235(W) x 295(H) x 21(D)mm
Buried Size	183(W) x 225(H) x 40(D)mm
Buried Box	KJB-800

[www.kocomhome.com](http://www.kocomhome.com)



# Guard Station

## KAM-300



### Function

- One-way video call with residents
- Voice call with lobby phone
- Communication with visitor & Gate open
- Bypass function
- Telephone function

### Specification

LCD	7" Touch LCD
Installation	Desktop Type
Speak Mode	Handset
Power	AC 100-240V, 50/60Hz
Surface Size	338(W) x 220(H) x 100(D)mm

Home Network



Home Automation



Videophone



Door Camera



Digital Doorlock



Sub Device



Interphone







Home Automation

# Home Automation System

KOCOM's Home Automation System includes a terminal(a wallpad), lobbyphone, a kitchen TV videophone, a sub-video phone, a bathroom phone and etc., and KOCOM has developed, manufactured and supplied from house to abroad with various Home Automation Devices.



[www.kocomhome.com](http://www.kocomhome.com)

# Home Automation System Diagram

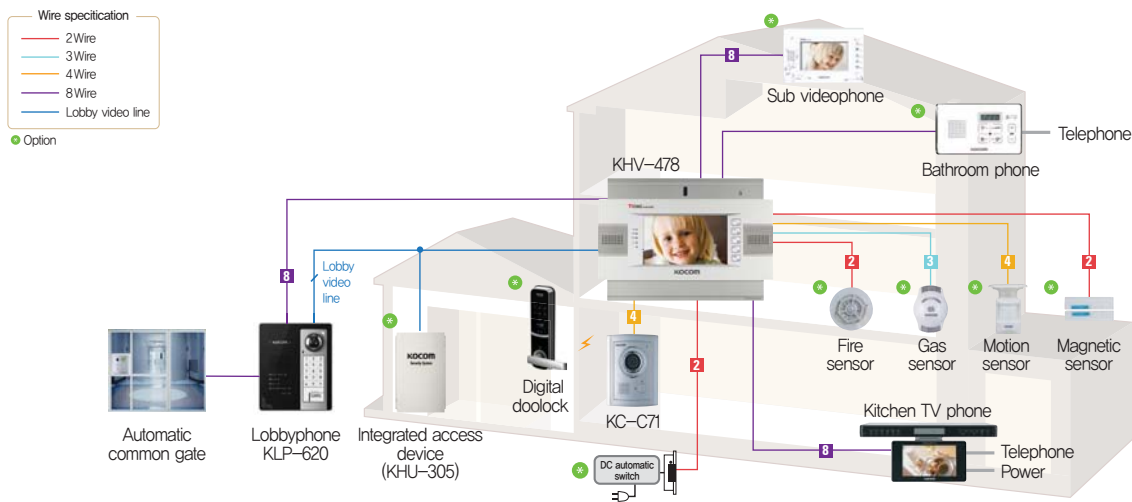

## Videophone

### KHN-478 / KHN-458 / KCV-358 C O L O R



#### Function

- Visitor identify & Communication with lobbyphone
- Door/gate open
- Mutual video communication between units/guards
- Telephone function

#### Option

- Security: Gas sensor (KHV-478, KHV-458), Security 1 (intruder sensor)
- Kitchen TV Sub videophone, Bathroom videophone, Stores visitor make (up to 32 PCS)

#### Specification

Display	- KHV-478 : 7" Color LCD - KHV-458 / KCV-358 : 5" Color LCD
Installation	Surface Type
Speak Mode	Hands-free(speaker phone)
Wiring	Camera(4 Wire), Sub device interlock(8 Wire)
Power	AC 220V, 50/60Hz
Surface size	330(W) x 232(H) x 17(D)
Buried size	225(W) x 180(H) x 53(D)

www.kocomhome.com

### KCV-574 / KCV-T574 C O L O R



#### Function

- Visitor identify & Communication with lobbyphone
- Door/gate open
- Mutual video communication between units/guards
- GUI support (KCV-T574)

#### Option

- Kitchen TV Videophone and Bathroom Phone
- Sensor 1 (Magnetic sensor)

#### Specification

Display	7" TFT LCD
Installation	Surface Type
Speak Mode	Hands-free(speaker phone)
Wiring	Camera(4 Wire), Sub device interlock(8 Wire)
Power	AC 220V, 50/60Hz
Surface Size	289(W) x 128(H) x 25(D)mm

### KCV-C776 C O L O R



#### Function

- Visitor identify & Communication with lobbyphone
- Door/gate open
- Mutual video communication between units/guards

#### Option

- Kitchen TV Videophone and Bathroom Phone
- Sensor 1 (Magnetic sensor), Sensor 2 (Infrared ray sensor)

#### Specification

Display	7" TFT LCD
Installation	Flush Type
Speak Mode	Hands-free(speaker phone)
Wiring	Camera(4 Wire), Sub device interlock(8 Wire)
Power	AC 100-240V, 50/60Hz
Surface Size	289(W) x 184(H) x 18.5(D)mm
Buried Size	200(W) x 145(H) x 53(D)mm

Home Network

Home Automation

Videophone

Door Camera

Digital Doorlock

Sub Device

Interphone

# Videophone

## KHN-870

C O L O R



### Function

- Visitor identify & Communication with lobbyphone
- Door/gate open
- Mutual video communication between units/guards
- Telephone function

### Option

- Gas, Sensor 1 (Magnetic sensor), Sensor 2 (Motion IR sensor)
- Kitchen TV, Sub videophone, Bathroom videophone, Stores visitor image (up to 32 PCS)

### Specification

Display	7" Color Digital Touch LCD
Installation	Surface Type
Speak Mode	Hands-free(speaker phone)
Wiring	Camera(4 Wire), interlocking sub-device(8 Wire)
Power	AC 100-240V, 50/60Hz
Surface Size	298(W) x 208(H) x 18,5(D)
Buried Size	225(W) x 240(H) x 105(D)mm

## KCV-C374

C O L O R



### Function

- Visitor identify & Communication with lobbyphone
- Door/gate open
- Mutual video communication between units/guards

### Option

- Kitchen TV Videophone and Bathroom Phone available (KCV-374K)
- Security (Magnetic sensor)

### Specification

Display	7" TFT LCD
Installation	Surface Type
Speak Mode	Hands-free(speaker phone)
Wiring	Camera(4 Wire), interlocking sub-device(8 Wire), Videophone(10 Wire)
Power	AC 100-240V, 50/60Hz
Surface Size	222(W) x 142(H) x 33(D)mm
Buried Size	225(W) x 240(H) x 105(D)mm

## KCV-C434

C O L O R



### Function

- Visitor identify & Communication with lobbyphone
- Door/gate open
- Mutual video communication between units/guards

### Option

- Kitchen TV Videophone and Bathroom Phone (KCV-374K), Sensor 1 (Magnetic sensor), Sensor 2 (Infrared sensor)

### Specification

Display	4,3" TFT LCD
Installation	Surface Type
Speak Mode	Hands-free(speaker phone)
Wiring	Camera(4 Wire), Videophone(10 Wire)
Power	AC 100-240V, 50/60Hz
Surface Size	140(W) x 195(H) x 34,2(D)mm

[www.kocomhome.com](http://www.kocomhome.com)

## KCV-J351

C O L O R



### Function

- Visitor identify & Communication with lobbyphone
- Door/gate open
- Mutual video communication between units (KCV-J351) / guards
- Auto storing visitor image (up to 250 PCS)

### Option

- Kitchen TV Videophone and Bathroom Phone (KCV-374K), Sensor 1 (Magnetic sensor), Sensor 2 (Infrared ray sensor)

### Specification

Display	3,5" TFT LCD
Installation	Flush Type
Speak Mode	Hands-free(speaker phone)
Wiring	Camera(4 Wire), Videophone(10 Wire)
Power	AC 100-240V, 50/60Hz
Surface Size	177(W) x 254(H) x 20(D)mm
Buried Size	127(W) x 203(H) x 30(D)mm



## Interphone

### KIP-300BA



#### Function

- Guardmaster call (PA) mode
- Mutual video communication between units
- Remote Control of Entrance
- Volume Control (3 Levels)
- Intercom
- Call & Door open (\*option)

#### Specification

Installation	Surface Type & Desktop Type
Speak Mode	Handset
Wiring	UTP CAT. 5E
Power	DC 12V
Surface Size	140(W) x 175(H) x 39(D)mm

### KIP-305



#### Function

- Communication with Guardphone (KAM-305)
- Telephone Type (10 key)
- Intercom

#### Specification

Installation	Surface Type & Desktop Type
Speak Mode	Handset
Wiring	UTP CAT. 5E
Power	DC 17V
Surface Size	165(W) x 220(H) x 80(D)mm

## Common Gate Lobbyphone

### KLP-620



#### Function

- One-way video call with residents
- Door open with password or RF-card (13.56MHz)
- LCD status display

#### Specification

Installation	Flush Type
Speak Mode	Hands-free(Speaker phone)
Power	AC 100-240V, 50/60Hz(DC 24V, 2A)
Surface Size	248(W) x 296(H) x 18,5(D)mm
Buried Size	183(W) x 225(H) x 40(D)mm

### KLP-305R2



#### Function

- One-way video call with residents
- Door open with password or RF-card (13.56MHz)

#### Specification

Installation	Flush Type
Speak Mode	Hands-free(Speaker phone)
Power	AC 100-240V, 50/60Hz(DC 24V, 2A)
Surface Size	235(W) x 295(H) x 21(D)mm
Buried Size	240(W) x 320(H) x 100(D)mm



## Guard Station

### KAM-305



#### Function

- One-way video call with residents
- Voice call with lobby phone
- Communication with visitor & Gate open
- Bypass function
- Emergency of households notification

#### Specification

Installation	Desktop Type
Speak Mode	Handset
Power	AC 100-240V, 50/60Hz
Surface Size	338(W) x 220(H) x 100(D)mm

[www.kocomhome.com](http://www.kocomhome.com)



## Integrated Access Device

### KHU-305

C O L O R



#### Function

- Required for network system between buildings
- More KHU-305 add-able for extending system
- Up to 1,200 phone units extendable
- Up to 99 lobbyphones extendable
- Up to 40 guardphones extendable
- Repeater among videophones, lobbyphones & guardmaster

#### Specification

Installation	Desktop Type
Power	AC 100-240V, 50/60Hz
Surface Size	300(W) x 421(H) x 147(D)mm



Videophone

# Videophone System

KOCOM videophone with high quality and stylish design has offered various product groups in accordance with each use for an apartment complex, a multiplex house, a villa, a single-family house and etc., and a customer may install and operate it easily and conveniently.







Videophone

# Security Videophone

## Security System Diagram

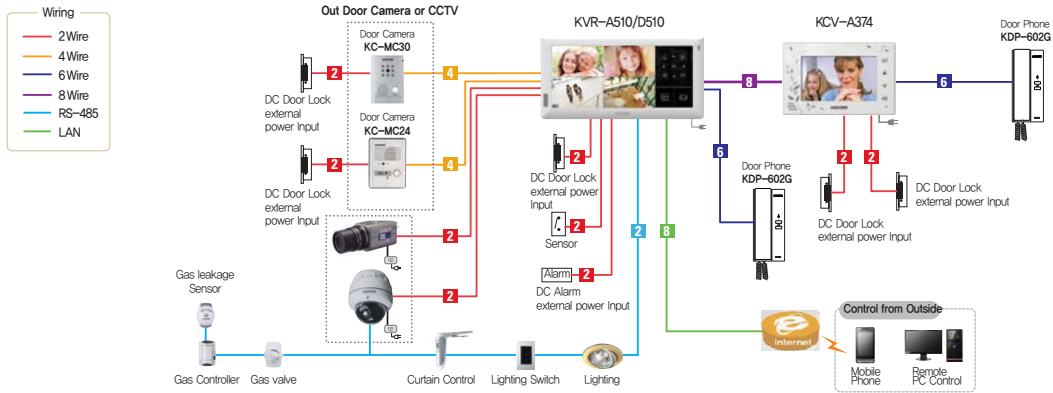

## KVR-A510 / KVR-D510

C O L O R



### Function

#### Videophone

- Visitor identify & Communication with lobbyphone
- Door open
- Home intercom
- Visitor video recording
- 5 melody choice
- Monitors CCTV or door camera

#### DVR

- Display : 10" Digital Color LCD (Touch)
- Input : 4CH Camera & Audio, 1CH Sensor
- Output : 1CH video out (composite), 1CH Alarm
- Live view : Digital Zoom (x 2), Monitoring Mode (1,4&PIP)
- Resolution : NTSC-720 x 480 / PAL-720x576
- Dual Network Stream : Local Recording & Network Transmission
- Home Control : lighting, curtain, gas, Digital Album, Calendar & Clock / Screen Saver

### Specification

Power	- KVR-A510 : AC 90V-240V, 50Hz/60Hz - KVR-D510 : DC 13.8V(0.5V), Max. 3.5A
Power Consumption	Max. : 30W ±20%
Surface Size	355(W) x 185(H) x 40(D)mm Cradle : 205(W) x 145(H) x 105(D)mm
Camera Connection	KC-C60, KC-MC30, KC-MC31, KC-MC24, KC-MC20

### Option



## KCV-544

C O L O R



### Function

- Visitor identify & Communication with lobbyphone
- Door open
- One-way video communication with guards
- Design choice (Transparent, Mirror front)
- Easy OSD menu

### Specification

- Display : 7" Digital Color LCD
- Power : AC 90-240V, 50/60Hz
- Power Consumption : Stand by 1.8W(±20%), Max. 12W(±20%)
- Surface Size : 223(W) x 130(H) x 33(D)mm
- Available Camera : KC-C60, KC-MC30, KC-MC31, KC-MC24, KC-MC20

### Diagram

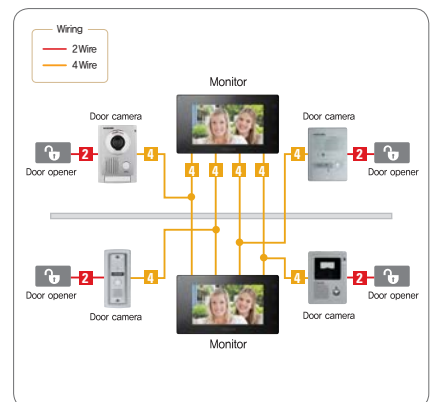



Videophone

# SD Card Videophone

## KCV-A374SD / KCV-D374SD

C O L O R



### Function

- Visitor identify & Communication
- Door open
- Easy OSD menu & Touch button
- Digital video recording
  - Up to 32GB SD card capable
  - MP4 (video), JPG (image) format
- Language: English, Spanish, French, Russian

### Specification

- Display : 7" Digital Color LCD
- Power : – KCV-A374SD : AC 100–240V, 50/60Hz  
– KCV-D374SD : DC 15V ±1V
- Power Consumption : Stand by 4W(±20%),  
Max. 15W(±20%)
- Surface Size : 222(W) x 144(H) x 33(D)mm
- Available Camera : KC-C60, KC-MC30, KC-MC31, KC-MC24, KC-MC20

### Diagram

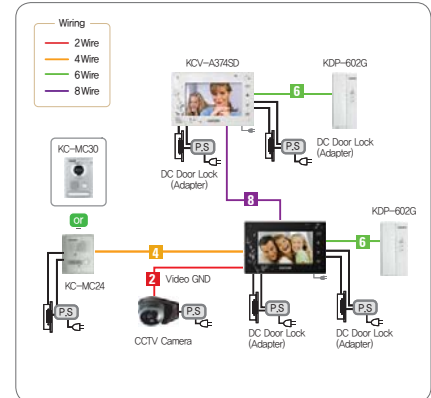

## KCV-434SD / D434SD

C O L O R



### Function

- Visitor identify & Communication
- Door open
- Easy OSD menu & Touch button
- Digital video recording
  - Up to 32GB SD card capable
  - MP4 (video), JPG (image) format
- Language: English, Spanish, French, Russian

### Specification

- Display : 4.3" Digital Color LCD
- Power : – KCV-434SD : AC 100–240V, 50/60Hz  
– KCV-D434SD : DC 15V, 2A
- Power Consumption : Stand by 3W(±20%),  
Max. 11W(±20%)
- Surface Size : 140(W) x 95(H) x 22(D)mm
- Available Camera : KC-C60, KC-MC30, KC-MC31, KC-MC24, KC-MC20

### Diagram

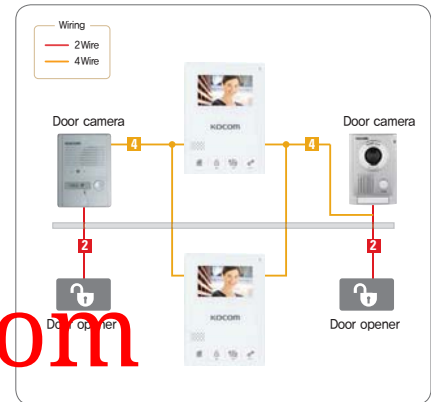

[www.kocomhome.com](http://www.kocomhome.com)

Home Network

Home Automation

Videophone

Door Camera

Digital Doorlock

Sub Device

Interphone



Videophone

# 6 Wire Bus Type Videophone



## Videophone

### KVR-A516

C O L O R



#### Function

- Visitor identify & Communication with lobbyphone
- Door open
- Home intercom
- Visitor video recording
- 5 melody choice
- Monitors CCTV or door camera (4CH)

#### Specification

- Display : 10" Color Digital Touch LCD
- Power : AC 100-240V~, 50/60Hz
- Power Consumption : 9W(ON STAND BY), 30W(FULL LOAD)
- Surface Size : 335(W) x 185(H) x 40(D)mm
- \*Cradle : 205(W) x 145(H) x 105(D)mm
- Available Camera : KC-C60, KC-MC30, KC-MC31, KC-MC24, KC-MC20

#### Diagram

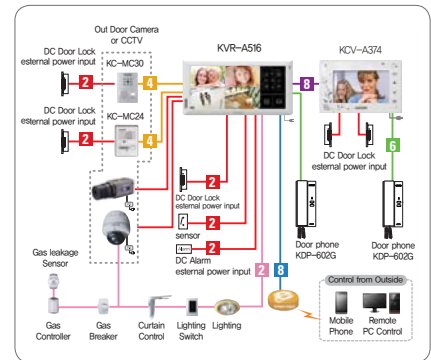

### KCV-A376 / KCV-D376

C O L O R



#### Function

- Visitor identify & Communication
- Door open
- Easy OSD menu & Touch button
- Call with Guard
- Intercom
- Monitors door camera

#### Specification

- Display : 7" Digital Color LCD(NTSC/PAL)
- Power : - KCV-A376 : AC 100-240V, 50/60Hz  
- KCV-D376 : DC 15V±10%
- Power Consumption :  
- KCV-A376 : Stand by 2.5W, Max. 13W  
- KCV-D376 : Stand by 2.5W, Max. 13W
- Surface Size : 222(W) x 144(H) x 33(D)mm
- Available Camera : KC-C60, KC-MC30, KC-MC31, KC-MC24, KC-MC20

#### Diagram

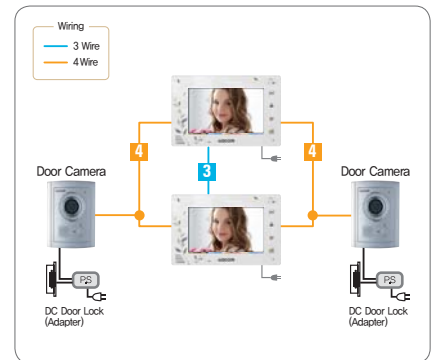

### KIV-212 / KIV-D212

C O L O R



#### Function

- Visitor identify & Communication
- Door/Gate Open
- Suits for house to villas (up to 450 units)
- Up to 4 indoor units (4 monitors & 1 audio handset)
- Up to 60 door camera
- Intercom
- Call with Guardmaster (KIV-123)
- Monitors door/gate camera

#### Specification

- Display : 5" TFT Color LCD(handfree videophone)
- Power : - KIV-212 : AC 100-240V, 50/60Hz  
- KIV-D212 : DC 17V±2V
- Power Consumption : Stand by 4.8W, Max. 19W
- Surface Size : 237(W) x 199(H) x 39(D)mm
- Available Camera : KC-C60, KC-MC30, KC-MC31, KC-MC24, KC-MC20

#### Diagram

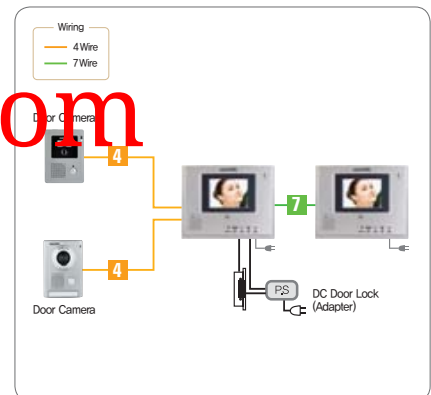

www.kocomhome.com



## KCV-436 / KCV-D436

C O L O R



### Function

- Visitor identify & Communication
- Door open
- Easy OSD menu & Touch button
- Call with Guard
- Monitors lobby camera (KLP-302/KLP-410 series, KLP-100 series)

### Specification

- Display : 4.3" Digital Color LCD
- Power : - KCV-436 : AC 90-240V, 50/60Hz  
- KCV-D436 : DC 15V, 2A
- Power Consumption : Standby 1W, Max. 8.5W(±20%)
- Surface Size : 140(W) x 195(H) x 32(D)mm
- Available Camera : KC-C60, KC-MC30, KC-MC31, KC-MC24, KC-MC20

### Diagram

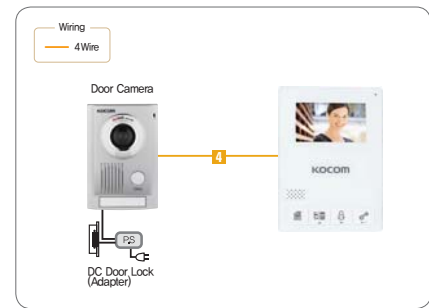

[www.kocomhome.com](http://www.kocomhome.com)  
Lobbyphone

## 6 Wire Bus Type Videophone System Diagram

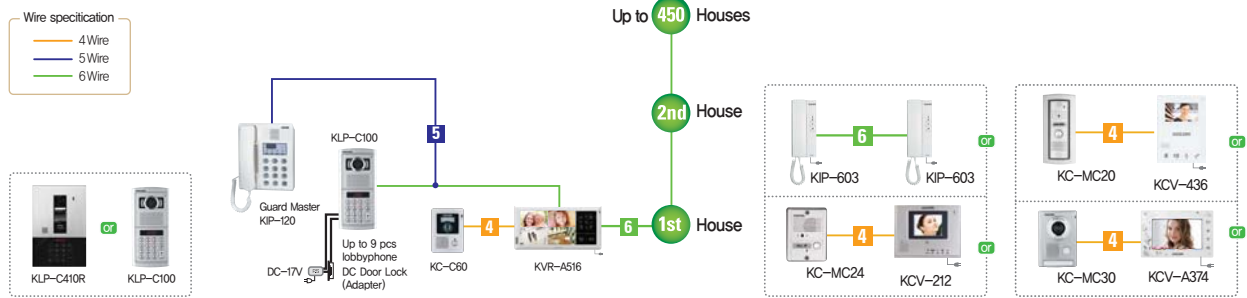

## KLP-C100 / KLP-C104 / KLP-C108 / KLP-C112



### Function

- C104 : Up to 4 units
- C108 : Up to 8units
- C112 : Up to 12 units
- C100 : Up to 450 units
- Call with Guardmaster (KLP-C100)
- Door open with Password or RF cards (\*option)
- Pinhole camera available (KLP-P series)

### Specification

Installation	Flush mount
Speak Mode	Handsfree
Wiring	Guard master(5 Wire), Videophone(6 Wire)
Power	DC 17V
Surface Size	122(W) x 255(H) x 33.5(D)mm
Box Size	101(W) x 223(H) x 105(D)mm

## KLP-C410R Series



### Function

- Household call & hold
- Guard call & hold
- Routed guard call
- Door open with Common gate PIN number
- House PIN number
- RF-card (KLP-C410R only)
- Audio Only Lobbyphone (※KLP-D410R)

### Specification

Installation	Flush Type
Speak Mode	Hands-free(Speaker phone)
Power	AC 200V, 50/60Hz(DC 18V, 2A)
Surface Size	173(W) x 262(H) x 14(D)mm
Buried Size	123(W) x 204(H) x 27(D)mm

[www.kocomhome.com](http://www.kocomhome.com)



Videophone

# 4 Wire Bus Type Videophone



## Videophone

### KCV-A510R

C O L O R



#### Function

- Visitor identify & Call with lobbyphone
- Door/Gate Open
- Home intercom
- Visitor image store
- 5 melody choice
- Monitors CCTV or door camera
- Sub devices available (\*option)

#### Specification

- Display : 10" Digital Color LCD(touch)
- Power : AC 100-240V~, 50/60Hz
- Power Consumption : Stand by 7.5W, Max. 21W
- Surface Size : 335(W) x 185(H) x 40(D)mm
- \*Cradle : 205(W) x 145(H) x 105(D)mm
- Available Camera : KC-C60, KC-MC30, KC-MC31, KC-MC24, KC-MC20

#### Diagram

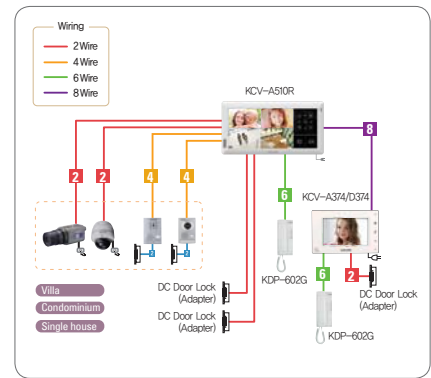

### KCV-A374 / KCV-D374

C O L O R



#### Function

- Visitor identify & Call with lobbyphone
- Door/Gate Open
- Intercom
- 5 melody choice
- Sub devices available (\*option)

#### Specification

- Display : 7" Digital Color LCD(high resolution)
- Power : - KCV-A374 : AC 100-240V~, 50/60Hz  
- KCV-D374 : DC 15V ±1V
- Power Consumption : Stand by 4W(±20%), Max. 15W(±20%)
- Surface Size : 222(W) x 144(H) x 33(D)mm
- Available Camera : KC-C60, KC-MC30, KC-MC31, KC-MC24, KC-MC20

#### Diagram

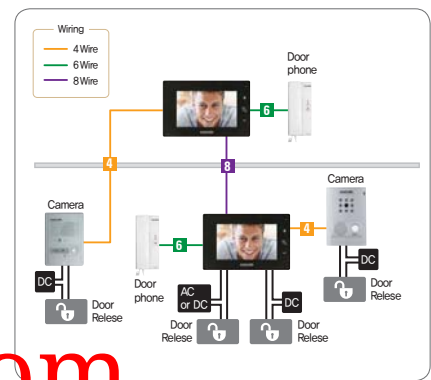

[www.kocomhome.com](http://www.kocomhome.com)

### KCV-340

C O L O R



#### Function

- Visitor identify & Call with door camera
- Door Open
- Intercom with extended PABX
- 5 melody choice
- Monitors CCTV

#### Specification

- Display : 4" Digital Color LCD
- Power : AC 90-240V, 50/60Hz
- Power Consumption : Stand by 1.5W, Max. 10W
- Surface Size : 207(W) x 215(H) x 60(D)mm
- Available Camera : KC-C60, KC-MC30, KC-MC31, KC-MC24, KC-MC20

#### Diagram

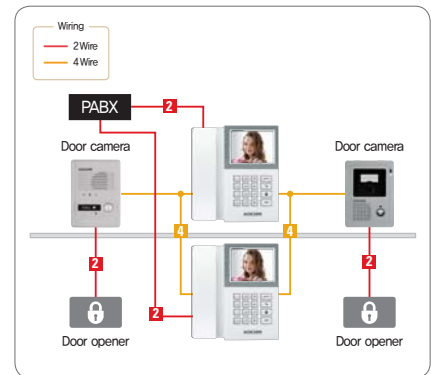

## KCV-301

C O L O R



### Function

- Visitor identify & Call with door camera
- Door open
- 5 melody choice
- 64 PCS image storage with memory device (KVR-300)

### Specification

- Display : 4" Digital Color LCD(NTSC/PAL)
- Power : AC 90~240V, 50/60Hz
- Power Consumption : Stand 1.6W, Max. 20W
- Surface Size : 190(W) x 215(H) x 55(D)mm
- Available Camera : KC-C60, KC-MC30, KC-MC31, KC-MC24, KC-MC20

### Diagram

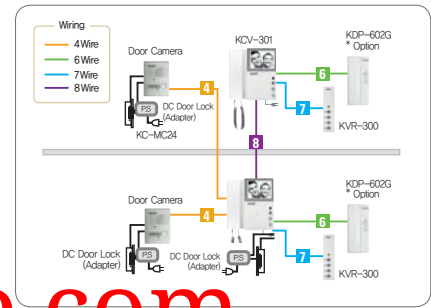

[www.kocomhome.com](http://www.kocomhome.com)

## KCV-W354 / KCV-DW354

C O L O R



### Function

- Visitor identify & Call with door camera
- Door open
- Home intercom
- 5 melody choice

### Specification

- Display : 3.5" Digital Color LCD
- Power : - KCV-W354 : AC 127V, 60Hz  
- KCV-DW354 : DC 15V, 1.2A
- Power Consumption :  
- KCV-W354 : Stand by 0.7W(±20%), Max. 13W(±20%)  
- KCV-DW354 : Stand by 1W(±20%), Max. 13W(±20%)
- Surface Size : 195(W) x 140(H) x 34(D)mm
- Available Camera : KC-C60, KC-MC30, KC-MC31, KC-MC24, KC-MC20

### Diagram

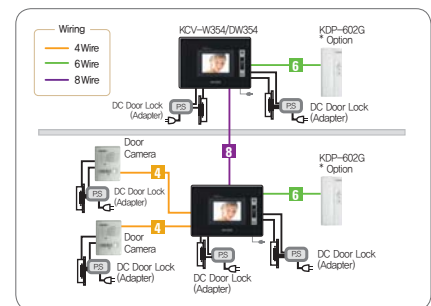

## Sub Audio Doorphone

## KDP-602G



### Function

- Audio call with door camera
- Door open
- Intercom
- Doorphone (KDP-602G) extendable

### Specification

Surface Size	92(W) x 210(H) x 57(D)mm
--------------	--------------------------

## 4 Wire Bus Type Videophone (Original Version) System Diagram

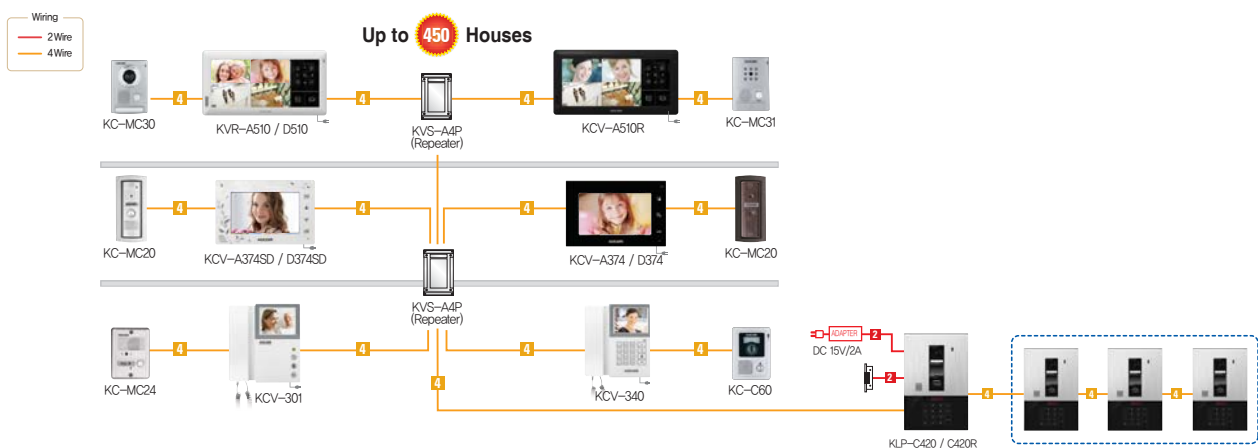

# Videophone

## KCV-504

C O L O R



### Function

- Visitor identify & Call with door camera
- Door open
- Call with Guardmaster
- LCD OSD menu

### Specification

- Display : 7" Digital Color LCD
- Power : AC 90-240V, 50/60Hz
- Power Consumption : Stand by 1.5W, Max. 11W(±20%)
- Surface Size : 223(W) x 130(H) x 26(D)mm
- Available Camera : KC-C60, KC-MC30, KC-MC31, KC-MC24, KC-MC20

### Diagram

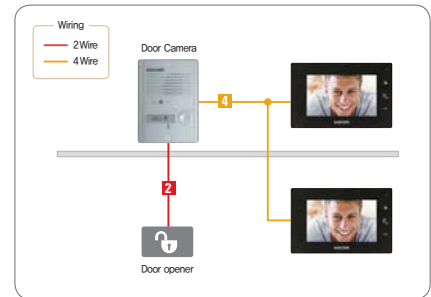

## KCV-434

C O L O R



### Function

- Visitor identify & Call with lobbyphone
- Door open
- Mutual call between units/guards
- OSD menu

### Specification

- Power : AC 90-240V, 50/60Hz
- Power Consumption : Stand by 1W, Max. 7.5W(±20%)
- Surface Size : 140(W) x 195(H) x 32(D)mm
- Available Camera : KC-C60, KC-MC30, KC-MC31, KC-MC24, KC-MC20

### Diagram

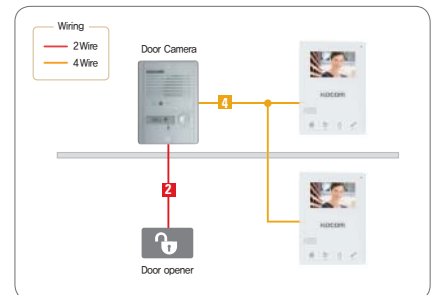

[www.kocomhome.com](http://www.kocomhome.com)

## KCV-454

C O L O R



### Function

- Visitor identify & Call with lobbyphone
- Door open
- Mutual call between units/guards
- OSD menu
- Guard phone/lobby phone connect-able (\*option)

### Specification

- Power : AC 90-240V, 50/60Hz
- Power Consumption : Standby 0.9W(±20%), Max. 9W(±20%)
- Surface Size : 193(W) x 195(H) x 29(D)mm (43.5(D))
- Available Camera : KC-C60, KC-MC30, KC-MC31, KC-MC24, KC-MC20

### Diagram

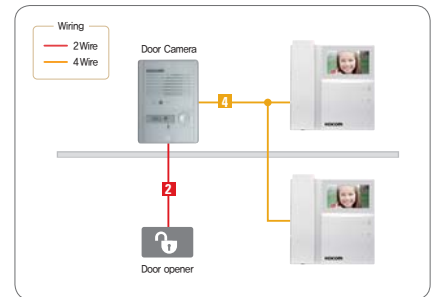

# Audio Doorphone

## KDP-602GD



### Function

- Audio call with door bell
- Door Open
- Intercom
- Doorphone (KDP-602G) extendable
- Available indoor unit : KVM-301, KCV-301, KCV-W354, KCV-801R, KCV-801

### Specification

Surface Size	92(W) x 210(H) x 57(D)mm
--------------	--------------------------



## 4 Wire Bus Type Videophone (New Version) System Diagram

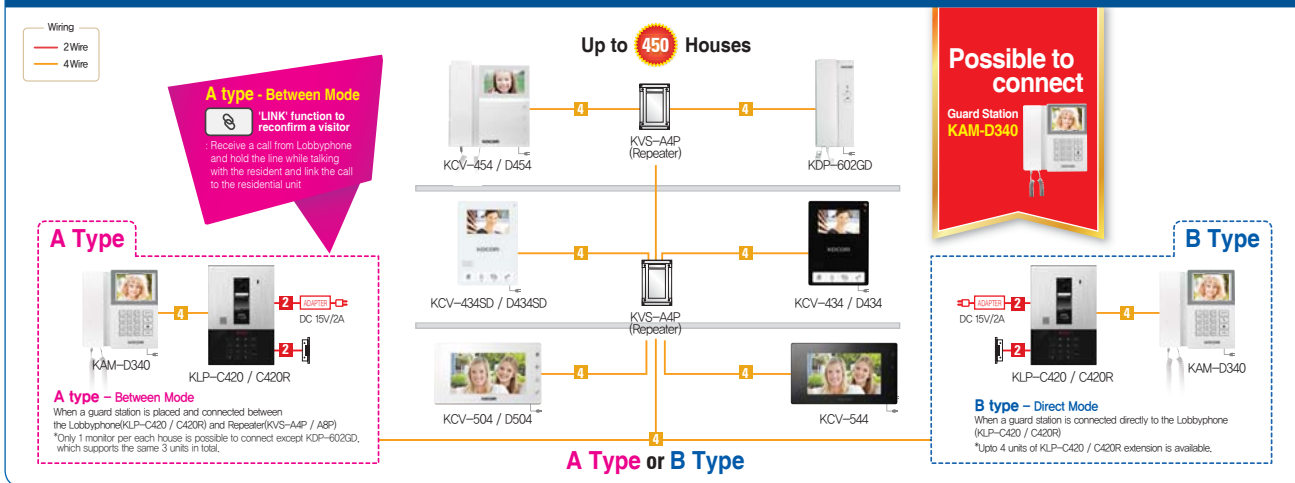

## Lobbyphone

### KLP-C420R Series



#### Function

- Video Call with residents
- Door Open
- Door Open with PIN number or RF card (C420RF only)
- Up to 4 lobbyphone expendable (C420 series)
- Up to 450 units registration
- Camera, keypad lits when dark

#### Specification

Speak Mode	Hands-free
Power	DC 15V ±1V
Surface Size	174(W) x 263(H) x 15(D)mm
Box	200(W) x 270(H) x 85(D)mm
RF card Interlocking	13.56MHz (KLP-C420RF)

[www.kocomhome.com](http://www.kocomhome.com)

### KVS-A4P / KVS-A8P



#### Function

- Power LED : Shows power input
- Lobby LED : Shows to lobbyphone connectivity
- House LED : Shows house connectivity

#### Specification

Power	DV 13V ±2V, Operation Max. 6~7W
Data Mode	TX/RX data mode(Kocom Protocol)
Surface Size	174(W) x 263(H) x 15(D)mm
Videophone Connection	Max. imun 4EA(KVS-A8P : 8EA)

## Guard Station

### KAM-D340



#### Function

- Visitor identify & Call with door camera
- Door Open
- Call with guard
- Intercom

#### Specification

Display	4" TFT LCD
Installation	Surface Type
Speak Mode	Handset
Wiring	Door Camera(4 Wire), Inter-houses(4 Wire)
Power	AC 220V, 50/60Hz
Surface Size	210(W) x 222(H) x 57(D)mm



Videophone

# EV Series Videophone

## KCV-802EV

COLOR



### Function

- Visitor identify & Call with door camera
- Door open
- Intercom with extended monitor (EV series only)
- Built in telephone

### Specification

- Display : 7" Digital Color TFT LCD(LED Type)
- Power : AC 90-240V, 50/60Hz
- Power Consumption : Stand by 1W, Max. 10W
- Surface Size : 190(W) x 215(H) x 55(D)mm
- Available Camera : KC-C60, KC-MC30, KC-MC31, KC-MC24, KC-MC20

### Diagram

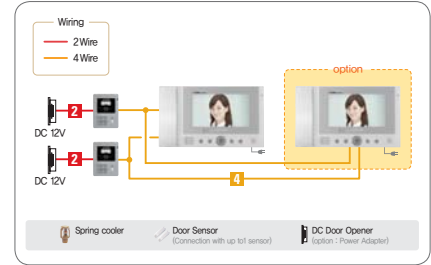

## KCV-801EV

COLOR



### Function

- Visitor identify & Call with door camera
- Door open
- Intercom with extended monitor (EV series only)

### Specification

- Display : 7" Digital Color TFT LCD(LED Type)
- Power : AC 90-240V, 50/60Hz
- Power Consumption : Stand by 1W, Max. 10W
- Surface Size : 190(W) x 215(H) x 55(D)mm
- Available Camera : KC-C60, KC-MC30, KC-MC31, KC-MC24, KC-MC20

### Diagram

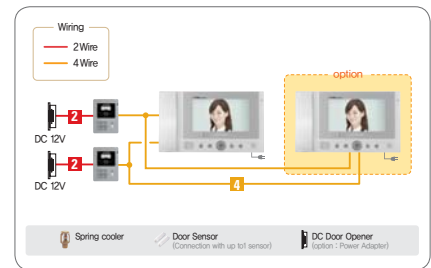

## KCV-401EV

COLOR



### Function

- Visitor identify & Call with door camera
- Door open
- Intercom with extended monitor

### Specification

- Display : 4" Digital Color LCD
- Power : AC 90-240V, 50/60Hz
- Power Consumption : Stand by 0.5W(±20%), Max. 5W(±20%)
- Surface Size : 140(W) x 195(H) x 32(D)mm
- Available Camera : KC-C60, KC-MC30, KC-MC31, KC-MC24, KC-MC20

### Diagram

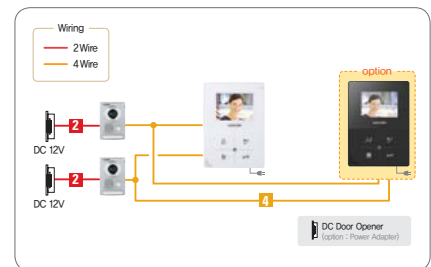

## KCV-301EV

COLOR



### Function

- Visitor identify & Call with door camera
- Door open
- Intercom with extended monitor

### Specification

- Display : 4" Digital Color LCD
- Power : AC 90-240V, 50/60Hz
- Power Consumption : Stand by 1.5W, Max. 10W
- Surface Size : 190(W) x 215(H) x 55(D)mm
- Available Camera : KC-C60, KC-MC30, KC-MC31, KC-MC24, KC-MC20

### Diagram

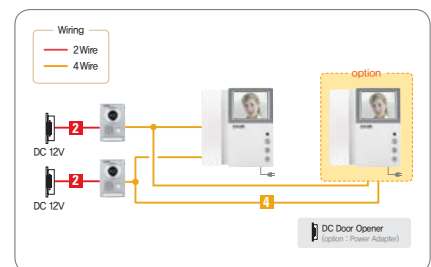



Videophone

# 2 Wire Non-Polarity Videophone

## KCV-A372 / KCV-D372

C O L O R



### Function

- Visitor identify & Call with door camera
- Door open
- Connection diagnosis between monitor to Camera

### Specification

- Power : - KCV-A372 : AC 100~240V, 50/60Hz  
- KCV-D372 : DC 12V ± 3V
- Power Consumption : Stand by 0.9W(±20%),  
Max. 15W(±10%)
- Surface Size :  
- KCV-D372 : 222(W) x 144(H) x 26.5(D)mm  
- KCV-A372 : 222(W) x 144(H) x 33(D)mm
- Available Camera : KC-C62, KC-MC32, KC-MC22,  
KC-MC11

### Diagram

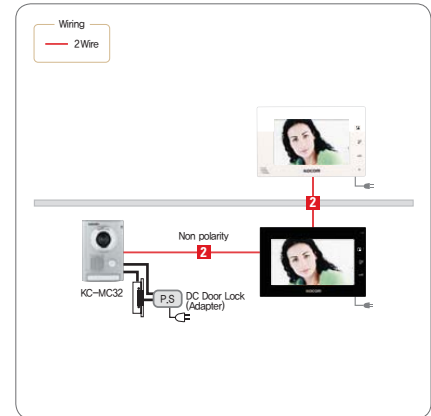

[www.kocomhome.com](http://www.kocomhome.com)

## KCV-352 / KCV-D352

C O L O R



### Function

- Visitor identify & Call with door camera
- Door open

### Specification

- Power : - KCV-A352 : AC 100~240V, 50/60Hz  
- KCV-D352 : DC 12V ± 3V
- Power Consumption :  
- On stand by : 0.7W(±20%)  
- During call : 10.5W(±10%)  
- Door open : 19W(±10%)
- Surface Size : 195(W) x 140(H) x 34(D)mm
- Available Camera : KC-C62, KC-MC32, KC-MC22,  
KC-MC11

### Diagram

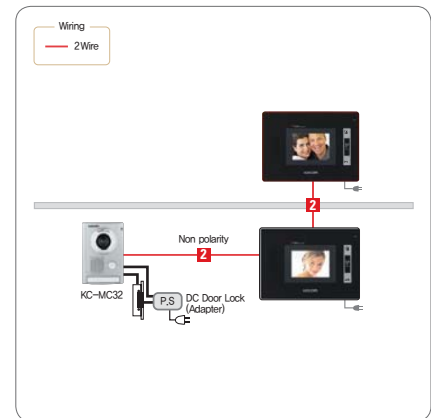

Home Network

Home Automation

Videophone

Door Camera

Digital Doorlock

Sub Device

Interphone



Videophone



# K6B Videophone System

## K6B Videophone System Diagram

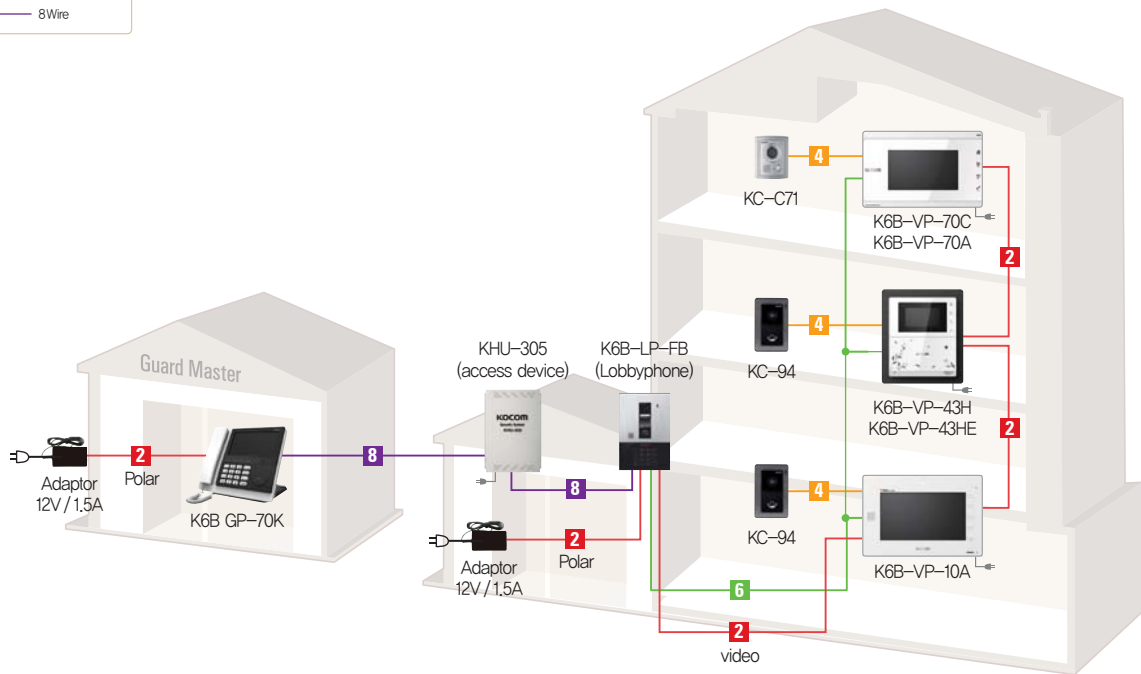
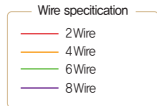

※ Adaptor Sold separately(Lobbyphone)



## Videophone

### K6B VP-10A

COLOR

[www.kocomhome.com](http://www.kocomhome.com)



#### Function

- Visitor identify & Communication with lobbyphone
- Door open
- Mutual video communication between unit/guards
- Sub devices available (option)

#### Option

- Kitchen TV Videophone
- Bathroom Phone

#### Specification

Display	10.1" TFT LCD
Installation	Flush Type
Speak Mode	Hands-free(speaker phone)
Wiring	Camera(4 Wire), Main Monitor(8 Wire—including an image of common gate)
Voice Line	1 Line
Power	AC 100-240V, 50/60Hz
Surface Size	316(W) x 214(H) x 16.8(D)mm
Buried Size	245(W) x 171(H) x 37(D)mm
Buried Box	KJB-800A
Lobbyphone	K6B VL-FB/35H/70D
Master	K6B GP-70K





# Videophone

## K6B VP-10A

C O L O R



### Function

- Visitor identify & Communication with lobbyphone
- Door open
- Mutual video communication between units/guards
- Sub devices available (\*option)

### Option

- Kitchen TV Videophone
- Bathroom Phone

### Specification

Display	7" TFT LCD
Installation	Flush Type
Speak Mode	Hands-free(speaker phone)
Wiring	Camera(4 Wire), Main Monitor(8 Wire—including an image of common gate)
Voice Line	1 Lines
Power	AC 100-240V, 50/60Hz
Surface Size	316(W) x 214(H) x 16.8(D)mm
Buried Size	245(W) x 171(H) x 37(D)mm
Buried Box	KJB-800A
Lobbyphone	K6B VL-FB/35H/70D
Master	K6B GP-70K

## K6B VP-70C

C O L O R



### Function

- Visitor identify & Communication with lobbyphone
- Door open
- Mutual video communication between units/guards
- Sub devices available (\*option)
- OSD/Status icon

### Specification

Display	7" TFT LCD
Installation	Surface Type
Speak Mode	Hands-free(speaker phone)
Wiring	Camera(4 Wire), Main Monitor(8 Wire—including an image of common gate)
Voice Line	1 Lines
Power	AC 100-240V, 50/60Hz
Surface Size	271(W) x 173(H) x 26(D)mm
Lobbyphone	K6B VL-FB/35H/70D
Master	K6B GP-70K

[www.kocomhome.com](http://www.kocomhome.com)

## K6B VP-43HE

C O L O R



### Function

- Visitor identify & Communication with lobbyphone
- Door open
- Mutual video communication between units/guards
- Kitchen TV, Sub phones (\*option)

### Specification

Display	4.3" TFT LCD
Installation	Flush Type
Speak Mode	Hands-free(speaker phone)
Wiring	Camera(4 Wire), Main Monitor(8 Wire—including an image of common gate)
Voice Line	1 Lines
Power	AC 100-240V, 50/60Hz
Surface Size	180(W) x 215(H) x 27(D)mm
Lobbyphone	K6B VL-FB/35H/70D
Master	K6B GP-70K

## K6B VP-43H

C O L O R



### Function

- Visitor identify & Communication with lobbyphone
- Door open
- Mutual video communication between units/guards
- Sub devices available (\*option)

### Specification

Display	4.3" TFT LCD
Installation	Surface Type
Speak Mode	Hands-free(speaker phone)
Wiring	Camera(4 Wire), Main Monitor(8 Wire—including an image of common gate)
Voice Line	1 Lines
Power	AC 100-240V, 50/60Hz
Surface Size	180(W) x 215(H) x 27(D)mm
Lobbyphone	K6B VL-FB/35H/70D
Master	K6B GP-70K

Home Network

Home Automation

Videophone

Door Camera

Digital Doorlock

Sub Device

Interphone



## Interphone

### K6B IP-4T



#### Function

- Visitor identify & Communication with lobbyphone
- Door open
- Mutual call between units/guards
- Absence mode

#### Specification

Installation	Surface Type
Speak Mode	Hands-free(speaker phone)
Wiring	Sub-phone(2 Wire), Main-phone(6 Wire)
Voice Line	1 Lines
Power	DC 14-18V
Surface Size	97,3(W) x 203,5(H) x 53,5(D)mm
Lobbyphone	K6B VL-FB/35H/70D
Master	K6B GP-70K



## Lobbyphone

### K6B LP-FB



#### Function

- Visitor identification and communication through Common gate camera (Lobby phone) and a video phone and door open
- Password set-up for each house unit
- RF card (13.5MHz) registration/deletable
- DVR image out-put / Striker operation
- Night-lit button & Camera back light by illumination sensor
- Adjustable camera angle / 15 touch keys
- Up to 4 channel video output
- 2 Wire System / Multiplex complex mode applicable
- 8 Wire system / two sensors addible
- Communication state notification

#### Specification

Display	4 DIGIT FND
Installation	Flush Type
Speak Mode	Hands-free(speaker phone)
Wiring	Sub-devices(8 Wire), Sensor(2 Wire), Auto-gate(2 Wire), Video(8 Wire for 4 channel)
Power	DC 24V
Surface Size	249(W) x 299(H) x 19(D)mm
Buried Size	191(W) x 232(H) x 29(D)mm
Buried Box	KJB-J300
Master	KAM-305, K6B GP-70K
Videophone	Existing 8 Wire & New K6B videophone
Main Equipment	KHU-305/320

### K6B LP-355



#### Function

- Visitor identify & Communication with lobbyphone
- Door open
- RF card (13.5MHz) registration/deletable
- DVR image out-put / Striker operation
- Night-lit button & Camera back light by illumination sensor
- Adjustable camera angle / 15 touch keys
- Up to 4 channel video output
- 2 Wire System / Multiplex complex mode applicable
- 8 Wire system / two sensors applicable
- Communication state notification

#### Specification

Display	3.5" COLOR LCD
Installation	Flush Type
Speak Mode	Hands-free(speaker phone)
Wiring	Sub-devices(8 Wire), Sensor(2 Wire), Auto-gate(2 Wire), Video(8 Wire for 4 channel)
Power	DC 24V
Surface Size	249(W) x 299(H) x 19(D)mm
Buried Size	191(W) x 232(H) x 29(D)mm
Buried Box	KJB-800
Master	KAM-305, K6B GP-70K
Videophone	Existing 8 Wire & New K6B videophone
Main Equipment	KHU-305/320



## Guard Station

### K6B GP-70K



#### Function

- Visitor identify & Call with Gate
- Door/Gate open
- Mutual communication between units/guards
- Bypass call in absence of a guard or a house unit
- Emergency situation of house unit displayed

#### Specification

Display	4.3" TFT LCD
Installation	Flush Type
Speak Mode	Hands-free(speaker phone)
Wiring	Camera(4 Wire), Main(8 Wire) & 2 ports (RJ45)
Voice Line	1 Lines
Power	AC 220V, 50/60Hz
Surface Size	257(W) x 225(H) x 39(D)mm(52,6(D)mm)
Lobbyphone	K6B VL-FB/35H/70D
Sensor Adds	2EA

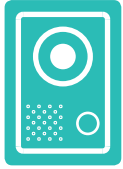

Door Camera

# Door Camera

KOCOM's door-camera is various in the different use, which is for Common resident, shopping district, office and so forth, and a customer is able to install and use more conveniently.



[www.kocomhome.com](http://www.kocomhome.com)



# 4 Wire Multi Entry Panel Camera

## System Configuration(up to 32 Houses)

2 Houses



3 Houses



4 Houses



6 Houses



8 Houses



14 Houses



15 Houses



15 Houses



15 Houses



32 Houses



www.kocomhome.com

## KVL-C302i / KVL-C303i / KVL-C304i / KVL-TC306i / KVL-TC308i



### Extension Panel

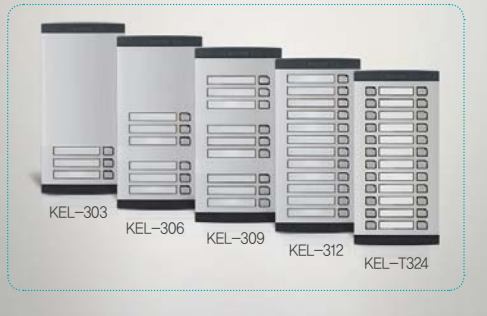

### Function

- Mutual call with residents
- Easy & simple installation
- Door Open by I-Button Key (Dallas Chip) – \*optional
- Up to 1,300 numbers of I-Button Key registration
- White LED for visitor recognition at night
- Button type :
  - KVL-C302i : Direct 2 push button type
  - KVL-C303i : Direct 3 push button type
  - KVL-C304i : Direct 4 push button type
  - KVL-TC306i : Direct 6 push button type
  - KVL-TC308i : Direct 8 push button type

### Specification

Installation	Flush mount
Power	DC 12V, 1.5A
Surface Size	125(W) x 290(H) x 16(D)mm
Box Size	115(W) x 282(H) x 50(D)mm
Compatible Monitor	KCV-301, KCV-W354/DW354, KCV-A374/D374/374SD, KCV-434/454, KCV-504/544, KVR-A510

### Option







# 2 Wire Multi Entry Panel Camera

## System Configuration(up to 40 Houses)

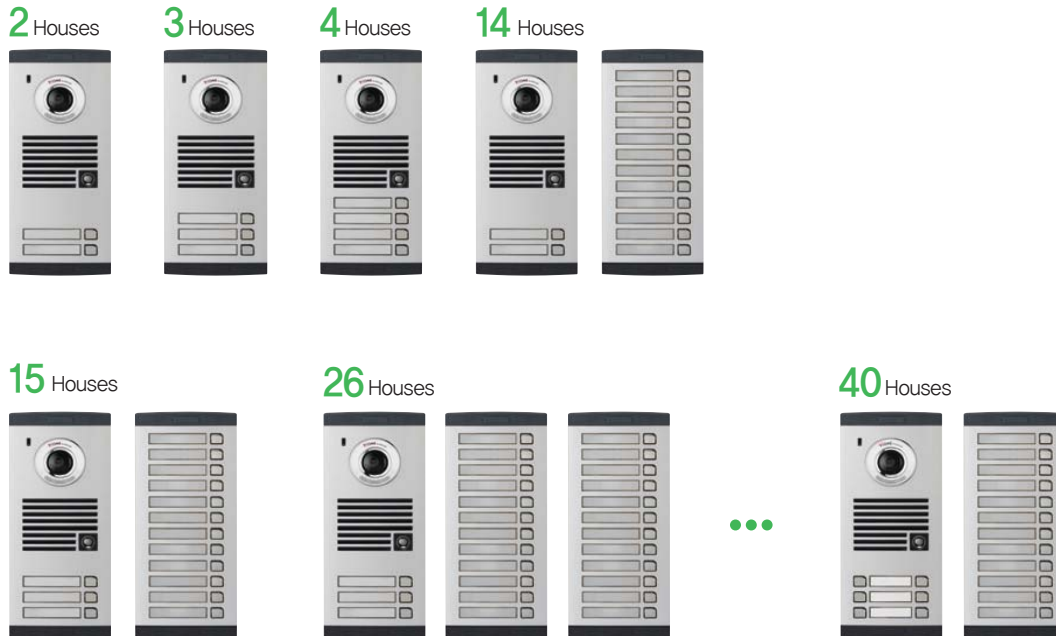

[www.kocomhome.com](http://www.kocomhome.com)

## KVL-C202i / KVL-C203i / KVL-C204i



KVL-C202i

KVL-C203i

KVL-C204i

### Function

- Mutual call with residents
- Easy & simple installation
- Door Open by I-Button Key (Dallas Chip) – (\*option)
- Up to 1,300 numbers of I-Button Key registration
- White LED for visitor recognition at night
- Button type :
  - KVL-C202i : Direct 2 push button type
  - KVL-C203i : Direct 3 push button type
  - KVL-C204i : Direct 4 push button type

### Specification

Surface Size	125(W) x 290(H) x 16(D)mm
Box Size	115(W) x 282(H) x 50(D)mm
Compatible Monitor	KCV-352/D352, KCV-D372

### Extension Panel



KEL-212

### Option



i Button  
KIB-01



Sunvisor  
SV30

Home Network

Home Automation

Videophone

Door Camera

Digital Doorlock

Sub Device

Interphone



# 4 Wire Door Camera

## KC-C71

C O L O R



### Specification

- Power : DC 12V±1V(power from monitor)
- Power Consumption : Max. 2.5W
- Wiring : 4 Wire
- Body Material : Plastic
- Installation : Flush mount
- Camera Angle : 100°(Angle Abjustable)
- Min. Illumination : 0.1 lux(LED ON)
- Surface Size : 89(W) x 131(H) x 13(D)mm
- Available Monitor :  
KHT-590, KHN-893, KHN-873,  
KHN-773/783, KHN-478/458/378,  
KCV-574/T574, KCV-C776, KHN-870,  
KCV-C374, KCV-C434, KCV-J351

### Wiring

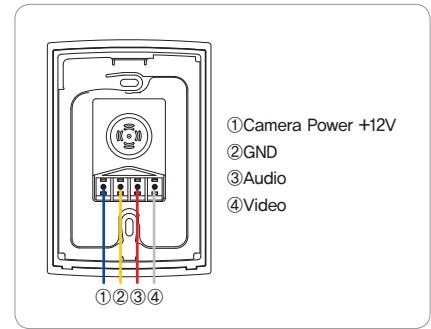

## KC-C60

C O L O R



### Specification

- Power : DC 12V±1V(power from monitor)
- Power Consumption : Max. 2.5W
- Wiring : 4 Wire
- Body Material : Plastic
- Installation : Surface mount
- Camera Angle : 100°(Fixed)
- Min. Illumination : 0.1 lux(LED ON)
- Surface Size : 95(W) x 127(H) x 34(D)mm
- Available Monitor :  
KVR-A510/D510, KCV-544, KCV-A374SD/  
D374SD, KCV-434SD, KVR-A516, KCV-A376/  
D376, KIV-212/D212, KCV-436, KCV-A510R,  
KCV-A374/D374, KCV-340, KCV-301,  
KCV-W354/DW354, KCV-504, KCV-434/D434,  
KCV-454/D454, KCV-802EV, KCV-801EV,  
KCV-401EV, KCV-301EV

### Wiring

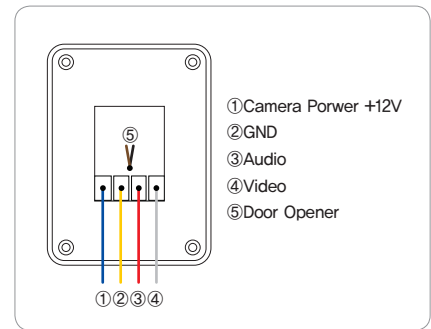

[www.kocomhome.com](http://www.kocomhome.com)

## KC-MC30

C O L O R



### Specification

- Power : DC 12V±1V(power from monitor)
- Power Consumption : Max. 3W
- Wiring : 4 Wire
- Body Material : Metal A/L
- Installation : Flush mount
- Camera Angle : 100°(Angle Abjustable)
- Min. Illumination : 0.1 lux(LED ON)
- Surface Size : 110(W) x 158(H) x 39(D)mm
- Available Monitor :  
KVR-A510/D510, KCV-544, KCV-A374SD/  
D374SD, KCV-434SD, KVR-A516, KCV-A376/  
D376, KIV-212/D212, KCV-436, KCV-A510R,  
KCV-A374/D374, KCV-340, KCV-301,  
KCV-W354/DW354, KCV-504, KCV-434/D434,  
KCV-454/D454, KCV-802EV, KCV-801EV,  
KCV-401EV, KCV-301EV

### Wiring

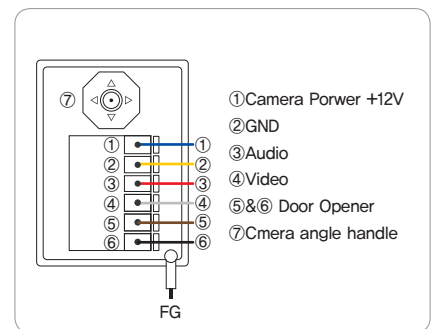

## KC-MC31

C O L O R



### Specification

- Power : DC 12V±1V(power from monitor)
- Power Consumption : Max. 2.5W
- Wiring : 4 Wire
- Body Material : Metal
- Installation : Surface mount
- Camera Angle : 100°(Fixed)
- Min. Illumination : 0.1 lux(LED ON)
- Surface Size : 110(W) x 158(H) x 39(D)mm
- Available Monitor :  
KVR-A510/D510, KCV-544, KCV-A374SD/  
D374SD, KCV-434SD, KVR-A516, KCV-A376/  
D376, KIV-212/D212, KCV-436, KCV-A510R,  
KCV-A374/D374, KCV-340, KCV-301,  
KCV-W354/DW354, KCV-504, KCV-434/D434,  
KCV-454/D454, KCV-802EV, KCV-801EV,  
KCV-401EV, KCV-301EV

### Wiring

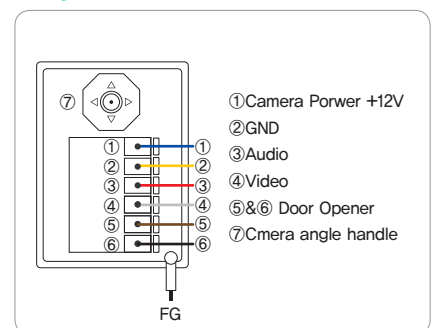



# 4 Wire Door Camera

## KC-MC24

C O L O R



### Specification

- Power : DC 12V±1V(power from monitor)
- Power Consumption : Max. 2.5W
- Wiring : 4 Wire
- Body Material : Metal
- Installation : Surface mount
- Camera Angle : 90°(Fixed)
- Min. Illumination : 0.1 lux on the object(LED ON)
- Surface Size : 95(W) x 127(H) x 32(D)mm
- Available Monitor :  
KVR-A510/D510, KCV-544, KCV-A374SD/D374SD, KCV-434SD, KVR-A516, KCV-A376/D376, KIV-212/D212, KCV-436, KCV-A510R, KCV-A374/D374, KCV-340, KCV-301, KCV-W354/DW354, KCV-504, KCV-434/D434, KCV-454/D454, KCV-802EV, KCV-801EV, KCV-401EV, KCV-301EV

### Wiring

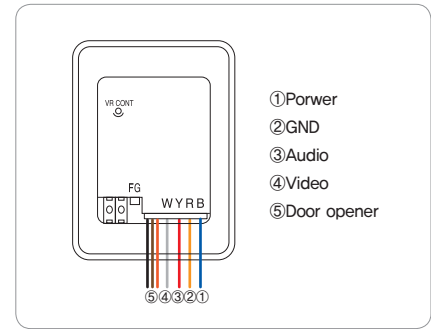

## KC-MC20

[www.kocomhome.com](http://www.kocomhome.com)

C O L O R



### Specification

- Power : DC 12V±1V(power from monitor)
- Power Consumption : Max. 2.5W
- Wiring : 4 Wire
- Body Material : Metal
- Installation : Surface mount
- Camera Angle : 90°(Fixed)
- Min. Illumination : 0.1 lux on the object(LED ON)
- Surface Size : 40(W) x 120(H) x 22(D)mm
- Available Monitor :  
KVR-A510/D510, KCV-544, KCV-A374SD/D374SD, KCV-434SD, KVR-A516, KCV-A376/D376, KIV-212/D212, KCV-436, KCV-A510R, KCV-A374/D374, KCV-340, KCV-301, KCV-W354/DW354, KCV-504, KCV-434/D434, KCV-454/D454, KCV-802EV, KCV-801EV, KCV-401EV, KCV-301EV

### Wiring

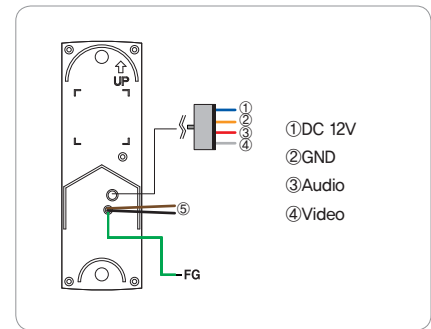

Home Network

Home Automation

Videophone

Door Camera

Digital Doorlock

Sub Device

Interphone



## 2 Wire Door Camera

### KC-C62

C O L O R



#### Specification

- Power : DC 12V±1V(power from monitor)
- Power Consumption : Max. 2.5W
- Wiring : 2 Wire
- Body Material : Plastic
- Installation : Surface mount
- Camera Angle : 100°(Fixed)
- Min. Illumination : 0.1 lux(LED ON)
- Surface Size : 95(W) x 127(H) x 34(D)mm
- Available Monitor :  
KCV-A372/D372, KCV-352/D352

#### Wiring

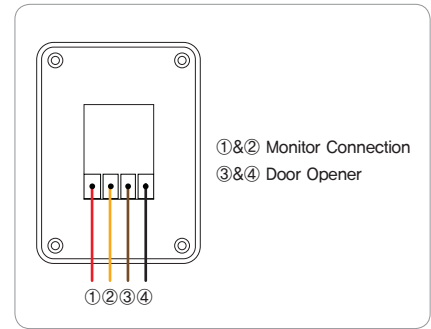

### KC-MC32

C O L O R



#### Specification

- Power : DC 12V±1V(power from monitor)
- Power Consumption : Max. 3W
- Wiring : 2 Wire
- Body Material : Metal A/L
- Installation : Surface mount
- Camera Angle : 100°(Angle Adjustable)
- Min. Illumination : 0.1 lux(LED ON)
- Surface Size : 110(W) x 158(H) x 39(D)mm
- Available Monitor :  
KCV-A372/D372, KCV-352/D352

#### Wiring

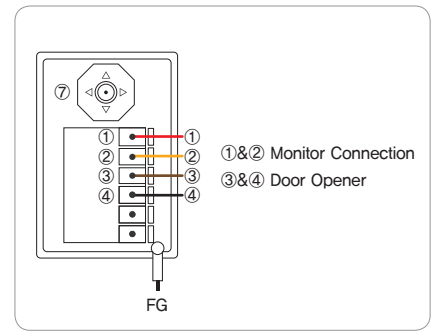

### KC-MC2

C O L O R

[www.kocomhome.com](http://www.kocomhome.com)



#### Specification

- Power : DC 12V±1V(power from monitor)
- Power Consumption : Max. 2.5W
- Wiring : 2 Wire
- Body Material : Metal
- Installation : Surface mount
- Camera Angle : 90°(Fixed)
- Min. Illumination : 0.1 lux on the object(LED ON)
- Surface Size : 95(W) x 127(H) x 32(D)mm
- Available Monitor :  
KCV-A372/D372, KCV-352/D352

#### Wiring

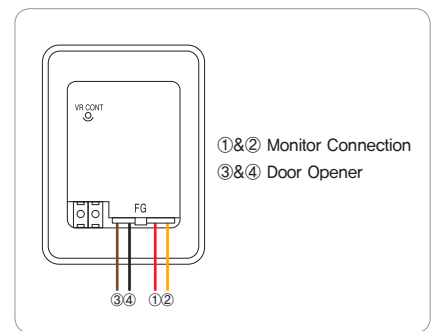

### KC-MC11

C O L O R



#### Specification

- Power : DC 12V±1V(power from monitor)
- Power Consumption : Max. 2.5W
- Wiring : 2 Wire
- Body Material : Metal
- Installation : Surface mount
- Camera Angle : 90°(Fixed)
- Min. Illumination : 0.1 lux on the object(LED ON)
- Surface Size : 40(W) x 120(H) x 22(D)mm
- Available Monitor :  
KCV-A372/D372, KCV-352/D352

#### Wiring

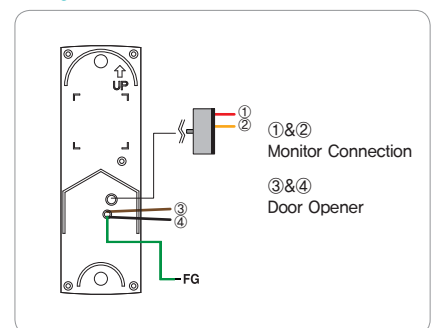





Digital Doorlock

# Digital Doorlock

KOCOM's digital doorlock makes your life more secure and convenient by applying an optimized function, strong body-protected design, and strengthened security technology.



[www.kocomhome.com](http://www.kocomhome.com)

# Digital Doorlock

## KDL-670SK / KDL-670S



### Function

- Premium Touch Pad
- Anti-panic mortise
- Interlocked into Home Automation System and remote control (\*option)
- Double security / Auto and Manual Locking
- Door open / close with one touch
- Random Security Code Feature and Low
- Low battery warning signal
- Password set-up (3~20 digits)
- Double locking from outside
- Up to 50 RF cards Registration
- Master Code management / Manner Mode
- Fire sensor / self-examining function
- Die-casting material

### Specification

Type	KDL-670SK (3Way)	<ul style="list-style-type: none"> <li>• RF Card(13.56MHz)</li> <li>• Password</li> <li>• Emergency key</li> </ul>
	KDL-670S (2Way)	<ul style="list-style-type: none"> <li>• RF Card(13.56MHz)</li> <li>• Password</li> </ul>
Power	DC 6V(AA 1.5V x 4EA)	
Surface Size	Front Ass'y : 74(W) x 295(H) x 25(D)mm Back Ass'y : 74(W) x 295(H) x 30(D)mm	

### Option

- Wireless connection function between Doorlock to Home Auto or Videophone

## KDL-2190 / KDL-2100



### Function

- Digital Touch Keypad
- Double-lock function
- Auto and Manual Locking
- Manner Mode
- Random Security Code Feature
- Up to 5 Passwords and 120 Fingerprints Registration
- Master Code Management
- Flameproof certified
- Die-casting material
- Low battery warning signal

### Specification

Type	KDL-2190 (3Way)	<ul style="list-style-type: none"> <li>• Finger print</li> <li>• Password</li> <li>• Emergency key</li> </ul>
	KDL-2100 (3Way)	<ul style="list-style-type: none"> <li>• RF Card(13.56MHz)</li> <li>• Password</li> <li>• Emergency key</li> </ul>
Power	DC 6V(AA 1.5V x 4EA)	
Surface Size	Front Ass'y : 75(W) x 300(H) x 30(D)mm Back Ass'y : 75(W) x 300(H) x 30(D)mm	

### Option

- Wireless connection function between Doorlock to Home Auto or Videophone

[www.kocomhome.com](http://www.kocomhome.com)

## KDL-2600 Series



### Function

- Digital Touch Keypad
- Double-lock function
- Auto and Manual Locking
- Random Security Code Feature
- Low battery warning signal
- Manner Mode
- Master Code Management
- Up to 5 Passwords and 50 RF cards Registration
- Flameproof certified

### Specification

KDL-2600 (3Way)	<ul style="list-style-type: none"> <li>• RF Card(13.56MHz)</li> <li>• Password</li> <li>• Emergency key</li> </ul>
Power	DC 6V(AA 1.5V x 4EA)
Surface Size	Front Ass'y : 78(W) x 290(H) x 25(D)mm Back Ass'y : 75(W) x 290(H) x 30(D)mm

### Option

- Wireless connection function between Doorlock to Home Auto or Videophone

## KDL-2000



### Function

- Digital Touch Keypad
- Auto and Manual Locking
- Door open / close with one touch
- One touch door open / close
- Random Security Code Feature and Low battery warning signal
- Up to 50 RF cards and 5 passwords Registration
- Master Code management / Manner Mode
- Fire sensor / self-examining function
- Flameproof certified / Die-casting material

### Specification

KDL-2000 (3Way)	<ul style="list-style-type: none"> <li>• RF Card(13.56MHz)</li> <li>• Password</li> <li>• Emergency key</li> </ul>
Power	DC 6V(AA 1.5V x 4EA)
Surface Size	Front Ass'y : 76(W) x 276(H) x 32(D)mm Back Ass'y : 76(W) x 280(H) x 40(D)mm

### Option

- Wireless connection function between Doorlock to Home Auto or Videophone

## KDL-2700



### Function

- Digital Touch Keypad
- Double-lock function
- Auto and Manual Locking
- Random Security Code Feature
- Low battery warning signal
- Manner Mode
- Master Code Management
- Up to 5 Passwords and 50 RF cards Registration
- Flameproof certified

### Specification

KDL-2600 (3Way)	<ul style="list-style-type: none"> <li>• RF Card(13.56MHz)</li> <li>• Password</li> <li>• Emergency key</li> </ul>
Power	DC 6V(AA 1.5V x 4EA)
Surface Size	Front Ass'y : 70(W) x 219(H) x 23(D)mm Back Ass'y : 72(W) x 210(H) x (D)mm

### Option

- Wireless connection function between Doorlock to Home Auto or Videophone

[www.kocomhome.com](http://www.kocomhome.com)

## KDL-650SK / KDL-650S / KDL-650N



### Function

- Digital Touch Keypad
- Double security / Auto and Manual Locking
- Random Security Code Feature
- Volume Control / Manner Mode
- Internal & External forced locking
- Intrusion and breakage alert
- Low battery warning signal

### Specification

Type	KDL-650SK (3Way)	<ul style="list-style-type: none"> <li>• RF Card(13.56MHz)</li> <li>• Password</li> <li>• Emergency key</li> </ul>
	KDL-650S (2Way)	<ul style="list-style-type: none"> <li>• RF Card(13.56MHz)</li> <li>• Password</li> </ul>
	KDL-650N (1Way)	<ul style="list-style-type: none"> <li>• Password</li> </ul>
Power	DC 6V(AA 1.5V x 4EA)	
Surface Size	Front Ass'y : 73(W) x 170(H) x 25(D)mm Back Ass'y : 73(W) x 170(H) x 30(D)mm	

Home Network

Home Automation

Videophone

Door Camera

Digital Doorlock

Sub Device

Interphone

## Digital Doorlock

### KDL-2400



#### Function

- Digital Touch Keypad
- Double-lock function
- Auto and Manual Locking
- Random Security Code Feature
- Master Code Management
- Manner Mode
- Up to 5 Passwords and 50 RF cards Registration
- Flameproof certified
- Low battery warning signal

#### Specification

<b>KDL-2400 (3Way)</b>	<ul style="list-style-type: none"> <li>• RF Card(13.56MHz)</li> <li>• Password</li> <li>• Emergency key</li> </ul>
<b>Power</b>	DC 6V(AA 1.5V x 4EA)
<b>Surface Size</b>	Front Ass'y : 75(W) x 220(H) x 68(D)mm Back Ass'y : 78(W) x 230(H) x 72(D)mm

#### Option

- Wireless Connection between Doorlock and Videophone

### KDL-1800



#### Function

- Digital Touch Keypad
- Auto and Manual Locking
- Random Security code feature
- Low battery warning signal
- Manner Mode / Master Code Management
- Up to 50 RF cards and 5 passwords Registration
- Flameproof certified
- Interface with KOCOM Video Door Phone and Home Automation

#### Specification

<b>Type</b>	<b>KDL-1800 (3Way)</b>	<ul style="list-style-type: none"> <li>• RF Card(13.56MHz)</li> <li>• Password</li> <li>• Emergency key</li> </ul>
<b>Power</b>	DC 6V(AA 1.5V x 4EA)	
<b>Surface Size</b>	Front Ass'y : 70(W) x 196(H) x 20(D)mm Back Ass'y : 70(W) x 196(H) x 25(D)mm	

#### Option

- Wireless connection function between Doorlock to Home Auto or Videophone

[www.kocomhome.com](http://www.kocomhome.com)

## Sub Digital Doorlock

### KDL-230S



#### Function

- Digital Touch Keypad
- Double-lock
- Auto and Manual Locking
- Manner Mode
- Random Security Code Feature
- Low battery warning signal
- Intrusion alert
- Flameproof certified

#### Specification

<b>KDL-230S (2Way)</b>	<ul style="list-style-type: none"> <li>• RF Card(13.56MHz)</li> <li>• Password</li> </ul>
<b>Power</b>	DC 6V(AA 1.5V x 4EA)
<b>Surface Size</b>	Front Ass'y : 68(W) x 173(H) x 24(D)mm Back Ass'y : 90(W) x 157(H) x 36(D)mm

#### Option

- Wireless connection function between Doorlock to Home Auto or Videophone



## KDL-310S / KDL-310N



- Function**
- Digital Touch Keypad
  - Double security
  - Auto and Manual Locking
  - Anti-password leakage
  - Intrusion and breakage alert

**Specification**

Type	KDL-310S (2Way)	· RF Card(13.56MHz) : 4 pieces · Password
	KDL-310N (1Way)	· Password
Power	DC 6V(AA 1.5V x 4EA)	
Surface Size	Front Ass'y : 64(W) x 175(H) x 24(D)mm Back Ass'y : 90(W) x 157(H) x 36(D)mm	

## Access Control System

### RF-1000



- Function**
- Double security
  - Auto and Manual locking
  - Anti-password leakage
  - Internal intrusion prevention
  - Intrusion and breakage alert
  - Alert on the state of a dead bolt
  - Fire warning alert
  - Low battery warning alert
  - Emergency power supply

**Specification**

Voltage	DC 12V, 1.2A
Lock Relay	DC 12V, 2A
Cards Capacity	1000
Pin Capacity	Public : 1 / Private : 1000
Internal Reader Frequency	ID mode : 125Khz IC mode : 13.56Mhz
Card Reader Distance	ID mode : 5~15cm IC mode : 3~5cm
Lock Interface	Relay output or Level output
Door Dell	1
Alarm Inteface	1

[www.kocomhome.com](http://www.kocomhome.com)

### RF-2000



- Function**
- Double security
  - Automatic and manual locking
  - Anti-password leakage
  - Internal intrusion prevention
  - Intrusion and breakage alert
  - Alert on the state of a dead bolt
  - Fire warning alert
  - Low battery warning alert
  - Emergency power supply

**Specification**

Voltage	DC 12V~24V, 1.2A
Lock Relay	DC 12V~24V, 2A
Cards Capacity	2000
Pin Capacity	Public : 1 / Private : 2000
Internal Reader Frequency	ID mode : 125Khz IC mode : 13.56Mhz
Card Reader Distance	ID mode : 5~15cm IC mode : 3~5cm
Lock Interface	Relay output or Level output
Door Dell	1
Alarm Inteface	1

Home Network

Home Automation

Videophone

Door Camera

Digital Doorlock

Sub Device

Interphone



Sub Device

## Sub-Device

KOCOM's sub-device makes the life of living convenient, being connectable to a videophone and the other sub-devices.

[www.kocomhome.com](http://www.kocomhome.com)



## ((( ))) Flush Type TV Phone

### KTD-103AX



#### Function

- Digital TV (Angle of view adjustable by 90° on both sides)
- FM radio
- Interlocked with a videophone or wall-pad (visitor identification, communication, and door open) : Controlled by touch
- Receive of an office line signal
- Controlled by a remote controller

#### Specification

Display	10.2" TFT LCD
Installation	Flush mount
Speak Mode	Hands-free(speaker phone)
Power	AC 100-220V, 50/60Hz (DC 12V, 3A - exclusive Adapter)
Surface Size	326(W) x 188(H) x 13(D)mm
Buried Size	227(W) x 121(H) x 92(D)mm
Videophone	KHN-783/773/880/870, KHV-478, KCV-358/C776/V776/C374K

### KTD-703AX



#### Function

- Digital TV (Angle of view adjustable by 90° on both sides)
- FM radio
- Interlocked with a videophone or wall-pad (visitor identification, communication, and door open) : Controlled by touch
- Receive of an office line signal
- Controlled by a remote controller

#### Specification

Display	7" TFT LCD
Installation	Flush mount
Speak Mode	Hands-free(speaker phone)
Power	AC 100-220V, 50/60Hz (DC 12V, 3A - exclusive Adapter)
Surface Size	268(W) x 168(H) x 13(D)mm
Buried Size	227(W) x 121(H) x 92(D)mm
Buried Box	Buried Box only used for Buried TV
Videophone	KHN-783/773/880/870, KHV-478, KCV-358/C776/V776/C374K

## ((( ))) Sub Videophone

### KSP-270



#### Function

- Visitor identify & Call with lobby phone
- Door/Gate Open

#### Specification

Display	7" TFT LCD
Installation	Flush mount
Speak Mode	Hands-free(speaker phone)
Power	AC 100-220V, 50/60Hz
Surface Size	298(W) x 208(H) x 18.5(D)mm
Buried Size	225(W) x 160(H) x 36(D)mm
Buried Box	KJB-801
Videophone	KHN-783/773/880/870, KHV-478, KCV-358/C776/V776/C374K

[www.kocomhome.com](http://www.kocomhome.com)

Home Network

Home Automation

Videophone

Door Camera

Digital Doorlock

Sub Device

Interphone

## ☎ Kitchen TV Videophone

### KTD-710T / KTD-70T



#### Function

- Digital TV (Angle of view adjustable by 90° on both sides)
- FM radio
- MP3, Digital clock, Frame
- Interlocked with a videophone or wall-pad (visitor identification, communication, and door open) : Controlled by touch
- Receive of an office line signal
- Controlled by a remote controller

#### Specification

Model	KTD-710T	KTD-70T
Display	10.2" TFT LCD	7" TFT LCD
Installation	Installed on kitchen sink	
Speak Mode	Hands-free(Speaker phone)	
Power	AC 100-220V, 50/60Hz	
Body Size	350(W) x 37(H) x 235(D)mm	350(W) x 37(H) x 235(D)mm
Monitor Size	375(W) x 170(H) x 30(D)mm	210(W) x 120(H) x 30(D)mm
Videophone	KHN-783/773/880/870, KHV-478, KCV-358/C776/V776/C374K	

### AVK-210



#### Function

- Touch screen Type, 3D GUI applied
- 10" high-resolution Digital TV
- Home Network and Automation is available with Radio and call received
- Cooking encyclopedia, Digital clock, alarm notification
- Remote controller available, USB 2.0 support
- Multi-media function (Video play, electronic album, MP3 play, Voice record)

#### Specification

Display	10.2" TFT LCD, Wide Type
Installation	Installed on the kitchen sink
Speak Mode	Hands-free(speaker phone)
Power	AC 100-220V, 50/60Hz
Body Size	261(W) x 17(H) x 271.5(D)mm
Monitor Size	260(W) x 165(H) x 22.8(D)mm
Videophone	KHN-783/773/880/870, KHV-478, KCV-358/C776/V776/C374K

### AVK-810



#### Function

- Touch screen Type, 2D GUI applied
- 10" high-resolution Digital TV
- Home Network and Automation is available with Radio and call received
- Digital clock, USB 2.0 support
- Remote controller available
- Multi-media function (Video play, electronic album, MP3 play, Voice record)

#### Specification

Display	10.2" TFT LCD, Wide Type
Installation	Installed on the kitchen sink
Speak Mode	Hands-free(speaker phone)
Power	AC 100-220V, 50/60Hz
Body Size	271(W) x 22(H) x 271.5(D)mm
Monitor Size	260(W) x 165(H) x 22.8(D)mm
Videophone	KHN-783/773/880/870, KHV-478, KCV-358/C776/V776/C374K

[www.kocomhome.com](http://www.kocomhome.com)

## ☎ Bathroom Phone

### TRH-100 / TRH-200



#### Function

- Clock display mode
- Call receiving
- Door open
- Call to guard / emergency call
- Volume control, button touch

#### Specification

Installation	Flush Type
Speak Mode	Hands-free(speaker phone)
Power	DC 12V(Powered by a house unit)
Surface Size	165(W) x 105(H) x 10(D)mm
Buried Box	Double Type switch box with 4 angles
Videophone	KHN-783/773/880/870, KHV-478, KCV-358/C776/V776/C374K

### KBP-200 / KBP-205



#### Function

- Visitor identification and communication through Common gate camera (Lobby phone)and door open
- Sending a call and communicating to a guard
- Receive of an office line signal
- Emergency signal sent out
- Digital clock display (KBP-205)

#### Specification

Installation	Flush Type
Speak Mode	Hands-free(speaker phone)
Power	DC 12V(Powered by a house unit)
Surface Size	165(W) x 116(H) x 15(D)mm
Buried Box	Double Type switch box with 4 angles
Videophone	KHN-783/773/880/870, KHV-478, KCV-358/C776/V776/C374K



## Black Box

### X200FHD



#### Function

- Outstanding image quality – Full HD & HD
- 3.5", Full-touch High resolution LCD
- 2.2 Mega Pixel Panasonic Sensor
- External GPS (\*option)
- Auto-Recovery for REC file & disc error
- Power discharge protection function
- Security LED & Voice Guide
- PC Viewer Program

#### Specification

Camera	Front 2.2m pixel / Rear 2m pixels
REC Channel	2Channel
REC Resolution	Front : FHD(1920 X 1080) Rear : HD(1280 X 720)
FPS	1CH : Front 30FPS 2CH : Front 25FPS / Rear 15FPS
Image Quality	1CH : Bitrate 12/10/8Mbps-FHD 2CH : Bitrate 6/5/4Mbps-HD
Power	DC 12-24V Free Voltage
LCD	3.5" TFT LCD
Size	104(W) x 71(H) x 36(D)mm

### BRAVO



#### Function

- 3" LCD Touch Screen Display
- 2Mega Pixel CMOS Sensor
- Front HD + Rear VGA
- 1CH : 30FPS / 2CH : 20/10FPS
- Security LED & Voice Guide
- External GPS (\*option)
- Built-in G-Sensor
- PC Viewer for Video, Map, GPS Data

#### Specification

Camera	Front 2.2M pixel / Rear 0.3M Pixels
REC Channel	2Channel
REC Resolution	Front : HD(1280 x 720) Rear : VGA(640 x 480)
FPS	1CH : Front 30FPS 2CH : Front 25FPS / Rear 10FPS
Image Quality	1CH : bitrate 8/6/4Mbps 2CH : bitrate 4/3/2Mbps
Power	DC 12-24V Free Voltage
LCD	3.0" TFT LCD
Size	106(W) x 53(H) x 25(D)mm

## Curtain

### KAR-4000



#### Function

- Remote control over drawing a curtain
- Simple and well-harmonized design
- Compatible with Home Network system

#### Specification

Power	AC 100-250V, 50~60Hz
Communication System	Wireless : 1way, 2way RF, H/N : RS-485
Speed Control Range	10 Levels
Open/Close Speed	25 cm/sec
Max. Rail Length	12 Meter / Single, 20 Meter / Tandem
Max. Curtain Weight	60kg / Single, 90kg / Tandem

[www.kocomhome.com](http://www.kocomhome.com)

### KSR-4200 / KSR-4301 / KSR-4300



#### Function(KSR-4200)

- Easy install : Attach at any location without wiring
- Wireless : Control at any house unit
- 2 channels : Select each unit for control (up to 2 units)
- Wide usage : Use as wall mounted or anywhere remote controller

#### Function(KSR-4301 / KSR-4300)

- Control blind angle with one button
- Manage up to 8 curtains status with LCD screen
- Curtain status shown
- Wireless control at any house place
- Selecting each curtain for control (up to 4 curtains)

Home Network

Home Automation

Videophone

Door Camera

Digital Doorlock

Sub Device

Interphone

## Emergency Switch

### Emergency Switch



#### Function

- Emergency signal for external help
- Simple and well-harmonized design at any wall

#### Specification

Power	Relay system
Flush Box	Switch 1 box
Installation	Wall
Option	Contacting to wall-pad and guard master
Surface Size	78(W) x 120(H) x 46(D)mm

## Lighting Switch

### KV-0404



#### Function

- Remote control of lighting
- Compatible with Home Network system
- Dimming and turn ON/OFF

#### Specification

Power	AC 100–240V, 50/60Hz
Control Circuit	Dimming & ON/OFF 4 circuits
Buried Box Size	221(W) x 129.2(H) x 62(D)mm
Body Size	195(W) x 120(H) x 8.5(D)mm

### KV-0400 / KV-0602 / KV-0800



#### Function

- Remote control of lighting
- Compatible with Home Network system
- Dimming and turn ON/OFF control, ON/OFF timer

#### Specification

Power	AC 100–240V, 50/60Hz
Buried Box Size	172(W) x 102(H) x 75(D)mm
Body Size	172(W) x 102(H) x 8(D)mm

[www.kocomhome.com](http://www.kocomhome.com)

### KV-3011 / KV-3012 / KV-5014 / KV-5021



#### Function

- Remote control of lighting
- Compatible with Home Network system
- Dimming and turn ON/OFF control, ON/OFF timer

#### Specification

Installation	Wall mount
Communication Type	RS-485
Power	AC 220V, 50/60Hz
Body Size	– Lighting switch 1 / 2 : 78(W) x 120(H) x 46(D)mm – Lighting switch 3 / 4 / 5 / 6 : 124(W) x 120(H) x 41(D)mm

# Security Sensor

## Gas detector(LNG/LPG)



### Specification

Installation	LNG : 30cm from the top / LPG : 30cm from the ground
Power	DH 12V(HA supply)
Surface Size	70(W) x 96(H) x 35(D)mm

## Fire detector(LNG/LPG)



### Specification

Installation	Kitchen
--------------	---------

## Gas valve circuit breaker / Controller



### Specification

Power	DH 12V(HA supply)
Installation	Kitchen
Wiring	DM, N, LTP, 4P

## Burglar detector(Magnetic S/W)



### Specification

Installation	A gate door, window
Surface Size	50(W) x 13(H) x 15(D)mm

[www.kocomhome.com](http://www.kocomhome.com)

## Motion sensor



### Specification

Installation	Balcony, Living room(ceiling type)
Surface Size	Ø135(W) x 45(H)mm

## IRsensor



### Specification

Installation	Balcony, Living room(ceiling & wall installed)
Detecting Range/Angle	10m / Max. 100° by the front side
Surface Size	70(W) x 99(H) x 45(D)mm

Home Network

Home Automation

Videophone

Door Camera

Digital Doorlock

Sub Device

Interphone

# 《 》 Intergrated Access Device

## KGVS-12P(Image distributor)



### Specification

Installation	<ul style="list-style-type: none"> <li>· Unmanned Guard system</li> <li>· Input : 4P or T</li> <li>· Output : 12P or T</li> </ul>
--------------	---

## Wireless connecting tool set(Digital doorlock)

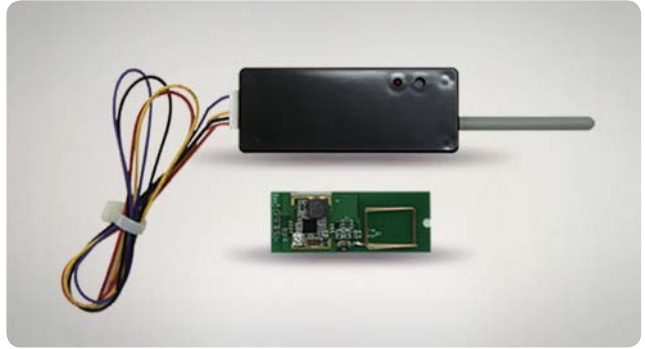

### Specification

Installation	<ul style="list-style-type: none"> <li>· Receiving part (Attached onto a doorlock)</li> <li>· Transmitting part (Attached onto videophone) → replace the remote controller</li> </ul>
--------------	---

## RF card(Loop type)



### Specification

Installation	<ul style="list-style-type: none"> <li>· Use : 125KHz (KLP-100RF)</li> <li>· 13.56MHz (Lobbyphone, Digital doorlock)</li> </ul>
--------------	---

## RF card(Card type)



### Specification

Installation	<ul style="list-style-type: none"> <li>· Use : 125KHz (KLP-100RF)</li> <li>· 13.56MHz (Lobbyphone, Digital doorlock)</li> </ul>
--------------	---

## KU-ESA(Repeater for Multi System)



### Specification

Installation	<ul style="list-style-type: none"> <li>· Up to 4 Door Cameras or CCTV Cameras &amp; 16 Monitors (2 Monitors PER 1 Port) connection</li> <li>· 2 More KU-ESA connections available in case of setting KU-ESA as SUB (Max. connection in case of using 3 KU-ESA : 12 Cameras &amp; 48 Monitors)</li> <li>· One selected Camera Monitoring available</li> <li>· Internal call &amp; Communication available between extended indoor units</li> <li>· Multi-call &amp; Vid</li> <li>· Monitor connection: KVR-A510/D510, KCV-A374/D374/A374SD/D374SD, KCV-W354/DW354, KCV-301</li> </ul>
--------------	--

### Diagram

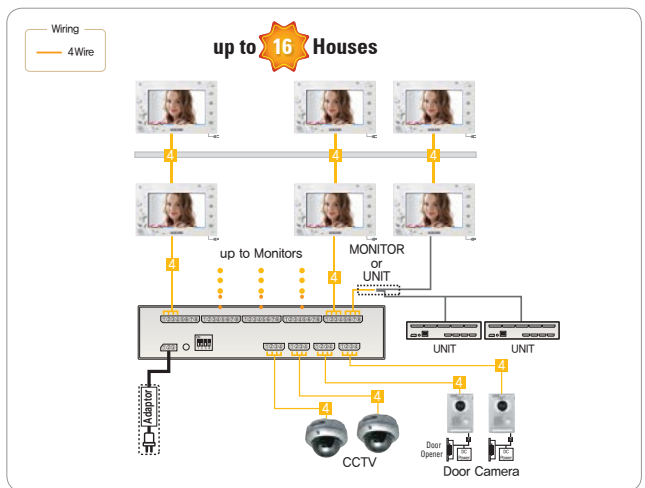



# ☎ Distributor

## KD-2AE



### Specification

Installation	Flush mount
Wiring	Image input(2 Wire), Image output(4 Wire for 2 channels)
Power	DC 12~24V
Surface Size	87.4(W) x 53.4(H) x 19.1(D)mm
Buried Size	75(W) x 55(H) x 20(D)mm
Available Unit	Lobbyphone, House unit(videophone)
Use	Amplify an image signal by the distance

## KD-4AM



### Specification

Installation	Flush mount
Wiring	Image input(2 Wire), Image output(8 Wire for 4 channels)
Power	DC 12~24V
Surface Size	87.4(W) x 53.4(H) x 19.1(D)mm
Buried Size	75(W) x 55(H) x 20(D)mm
Available Unit	Lobbyphone, House unit(videophone)
Use	Distribute an image

## KD-CB



### Specification

Installation	Flush mount
Wiring	Image input(2 Wire), Image output(2 Wire)
Power	N/A(Passive component)
Available Unit	Lobbyphone, House unit(videophone)
Use	Convert a coaxial image into UTP image

## KLV-12



### Specification

Installation	Flush mount
Wiring	Image input/output(4 Wire), Power/Image of a resident/control(5 Wire)
Available unit	Lobbyphone, House unit(videophone)
Use	Minimize the loss of image on installation of a camera

## KTDJR-12



### Specification

Connectable Unit	The relay for AC ON/OFF function
Use	Videophone, Home Automation for DC ON/OFF switch AC ON/OFF switch for a relay

Home Network

Home Automation

Videophone

Door Camera

Digital Doorlock

Sub Device

Interphone

[www.kocomhome.com](http://www.kocomhome.com)



Interphone

# Interphone System

KOCOM's interphone is various in the different use, which is for Common resident, shopping district, office and so forth, and a customer is able to install and use more conveniently.

[www.kocomhome.com](http://www.kocomhome.com)



# Bus Type Multi Audio Doorphone System

## KDP-100 / KDP-104 / KDP-108 / KDP-112



### Function

- Up to 4 houses (KDP-104), 8 houses (KDP-108), 12 houses (KDP-112)
- Upto 450 houses connection (KDP-100)
- Communication with a guard master (KDP-100)
- Door open function by access code (KDP-100)
- Upto 4pcs of common gate panels connection in a building

### Specification

- Installation : Flush Type
- Speak Mode : Hands-free
- Wiring : 5 common Wire
- Power : DC 17V ±2V(Powered from a power supply)
- Surface Size : 122(W) x 225(H) x 23.5(D)mm
- Box Size : 101(W) x 223(H) x 105(D)mm
- Max. Wiring distance : 0,8 single cable(300m)

## Diagram

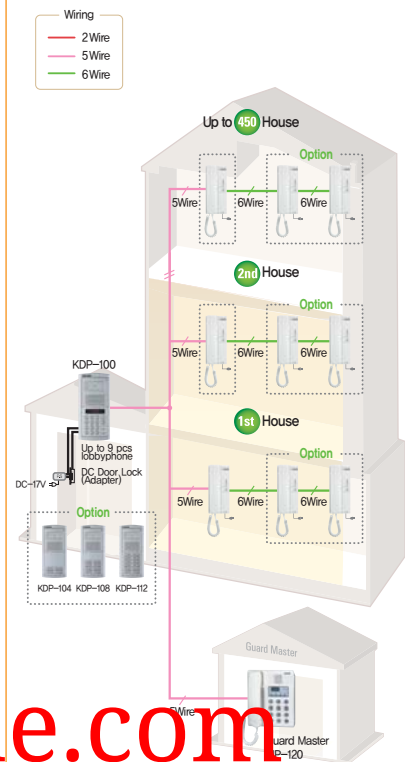

## KIP-603



### Function

- Up to 3 indoor extensions in a house and up to 450 units extendable
- Internal call & conversation function between extended indoor units in a house
- Audio conversation with a visitor
- Door (common gate) open function
- Call & communication with a guard master (KIP-120)

### Specification

- Installation : Surface Type
- Speak Mode : Handset
- Wiring : Outdoor panel(2 Wire), Inter-houses(5 Wire)
- Power : DC 18V, 2A
- Surface Size : 92(W) x 210(H) x 57(D)mm

[www.kocomhome.com](http://www.kocomhome.com)

## KDP-603



### Function

- Communication with door panel (DS-2D) & common gate panel (KDP-100 series)
- Guard Master Phone (KIP-120) call & Communication
- House no. setting by DIP SW setting
- Door open function during communication

### Specification

- Installation : Surface Type
- Speak Mode : Handset
- Wiring : Outdoor panel(2 Wire), Inter-houses(5 Wire)
- Power : DC 18V, 2A
- Surface Size : 92(W) x 210(H) x 57(D)mm

## Diagram

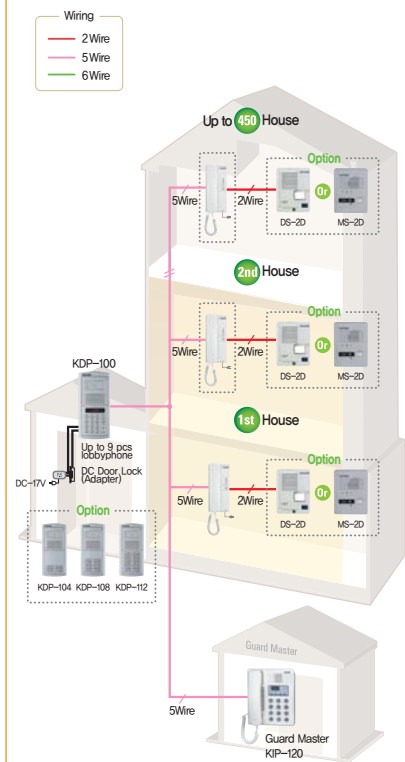

## KIP-120



### Function

- Call & Communication Function with Resident & Extended KIP-120 (Up to 10pcs in a system)
- Call Cancel Function
- Each phone Line Check Function
- Door open

### Specification

- Installation : Surface Type
- Speak Mode : Handset
- Wiring : 5 Wire
- Power : DC 17V ±1V
- Surface Size : 165(W) x 220(H) x 80(D)mm

Home Network

Home Automation

Videophone

Door Camera

Digital Doorlock

Sub Device

Interphone

## Bus Type Multi Audio Doorphone System

### KLP-1000



#### Function

- Door Open Function by Access Code
- Up to 2pcs of Common Gate Panel Connection in a Building
- Max. connection : Up to 585 house units

#### Specification

- Installation : Surface & Flush Type
- Speak Mode : Handstree
- Wiring : 3 Wire
- Power : DC 15V±1V
- Surface Size : 210(W) x 182(H) x 25(D)mm
- Available Doorphone : KDP-205

### Diagram

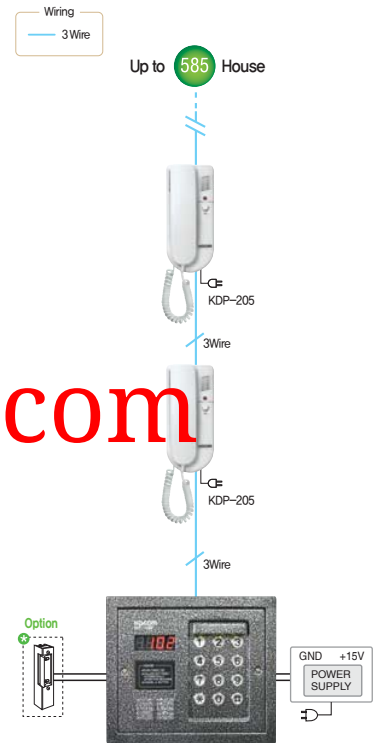

## www.kocomhome.com

### KDP-205



#### Function

- Audio Communication with visitor
- Door Open (Common gate)
- Call & Communication function with Common Gate pannel (KLP-1000)
- For multi Apartment, Condominium & Villa System, Up to 585 Houses are Available

#### Specification

- Installation : Surface Type
- Speak Mode : Handset
- Wiring : 3 Wire
- Power : DC 15V±1V
- Surface Size : 95(W) x 214(H) x 64(D)mm

## Duplex Interphone & Doorphone

### KIP-222



#### Function

- Audio Communication with Visitor
- Door Open
- Up to 3 Houses Connection
- Gentle Electronic Sound
- Easy Installation (mount on the Wall or Desk)

#### Specification

- Installation : Surface Type
- Speak Mode : Handset
- Wiring : 2 Wire
- Power : AC 110V or AC 220V
- Surface Size : 95(W) x 214(H) x 57(D)mm

### Diagram

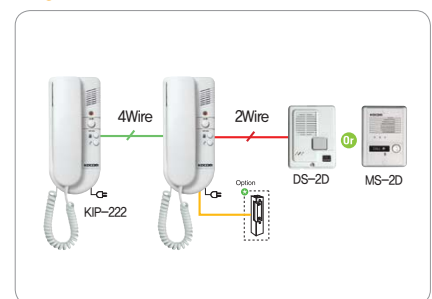

### KDP-602A/D



#### Function

- Audio Communication with visitor
- Door open
- Internal Call & Communication with Extended Units
- Duplex Interphone & Doorphone
- Up to 2 Audio Handset with 1 Outdoor Panel Connection
- Gentle Electronic Sound
- Easy Installation (Mount on the Wall or Desk)

#### Specification

- Installation : Surface Type
- Speak Mode : Handset
- Wiring : 2 Wire
- Power : AC 110V or AC 220V
- Surface Size : 92(W) x 210(H) x 57(D)mm

### Diagram

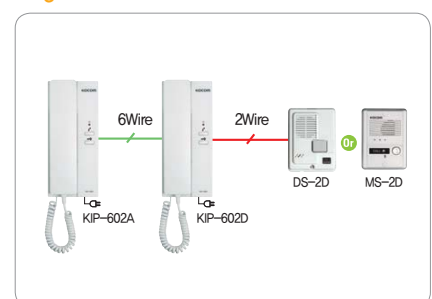



# Audio Doorphone

## DP-203HA



### Function

- Audio Communication with Visitor
- Door Open
- Up to 3 Houses Connection
- Gentle Electronic Sound
- Easy Installation (mount on the Wall or Desk)

### Specification

- Installation : Surface Type
- Speak Mode : Handset
- Wiring : 2 Wire
- Power : AC 110V or AC 220V
- Surface Size : 95(W) x 214(H) x 64(D)mm

## KDP-601A



### Function

- Audio Communication with Visitor
- Door Open
- Up to 3 Houses Connection
- Gentle Electronic Sound
- Easy Installation (mount on the Wall or Desk)

### Specification

- Installation : Surface Type
- Speak Mode : Handset
- Wiring : 2 Wire
- Power : AC 110V or AC 220V
- Surface Size : 95(W) x 210(H) x 57(D)mm

## KDP-501A



### Function

- Audio Communication with Visitor
- Door Open
- Up to 3 Houses Connection
- Gentle Electric Sound
- Easy Installation (mount on the Wall or Desk)

### Specification

- Installation : Surface Type
- Speak Mode : Handset
- Wiring : 2 Wire
- Power : AC 110V or AC 220V
- Surface Size : 95(W) x 214(H) x 64(D)mm

## DP-906H



### Function

- Audio Communication with Visitor
- Door Open
- Gentle Electronic Sound
- 4 Melody Selection
- Easy Installation (Mount on the Wall or Desk)

### Specification

- Installation : Surface Type
- Speak Mode : Handset
- Wiring : 2 Wire
- Power : DC 6V(AA 1.5V battery) x 4ea
- Surface Size : 92(W) x 210(H) x 57(D)mm

## Diagram

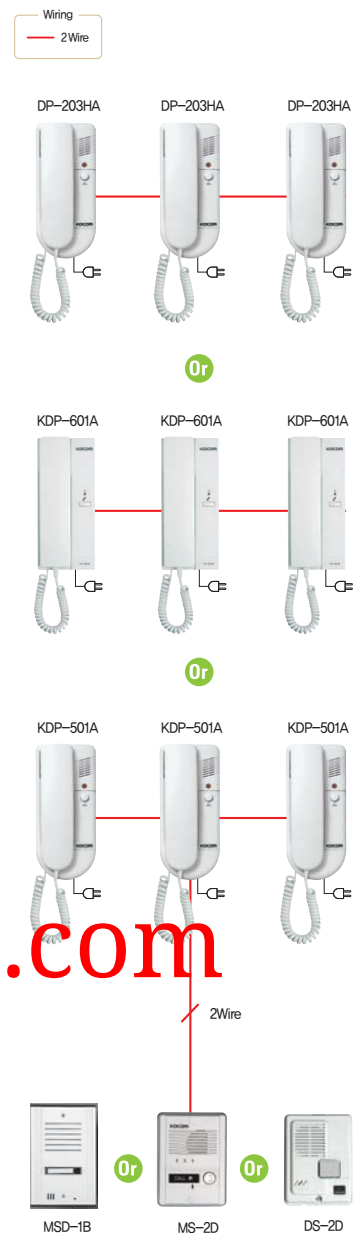

## Diagram

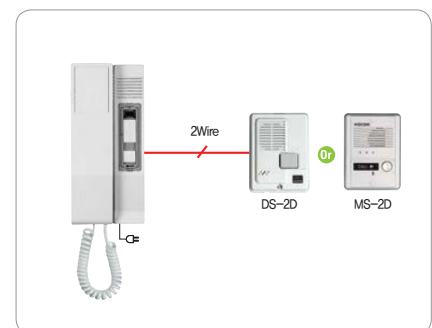

[www.kocomhome.com](http://www.kocomhome.com)

Home Network

Home Automation

Videophone

Door Camera

Digital Doorlock

Sub Device

Interphone

## Audio Outdoor Panel

### DS-2D



#### Function

- Single house outdoor panel
- Call Household

#### Specification

Installation	Surface Type
Speak Mode	Handfree
Wiring	DS-2D : 2 Wire
Power	Powered from audio handset
Surface Size	99(W) x 131(H) x 30(D)mm
Body Material	Plastic

### MS-2D



#### Function

- Single house outdoor panel
- Call Household
- Metal enclosure

#### Specification

Installation	Surface Type
Speak Mode	Handfree
Wiring	2 Wire
Power	Powered from audio handset
Surface Size	95(W) x 127(H) x 32(D)mm
Body Material	Metal

[www.kocomhome.com](http://www.kocomhome.com)

### MSD-1B / MSD-2B / MSD-3B / MSD-4B

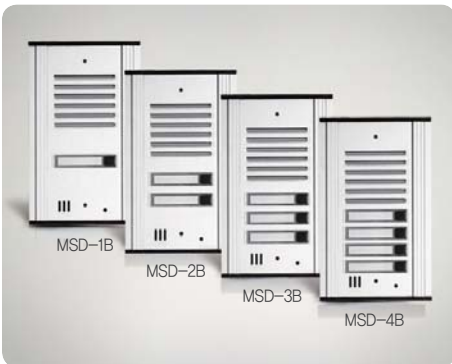

#### Function

- Aluminum Common Gate Panel
- 1 House (MSD-1B) / Upto 2 House (MSD-2B)
- Up to 3 House (MSD-3B) / Upto 4 House (MSD-4B)
- Rain Proof, Metal Anti Vandal

#### Specification

Installation	Flush Type
Speak Mode	Handfree
Wiring	2 Wire
Power	Powered from audio handset
Surface Size	122(W) x 199(H) x 35(D)mm
Body Material	Aluminum

# Multi Audio Doorphone System

## Audio Lobbyphone & Interphone System Diagram

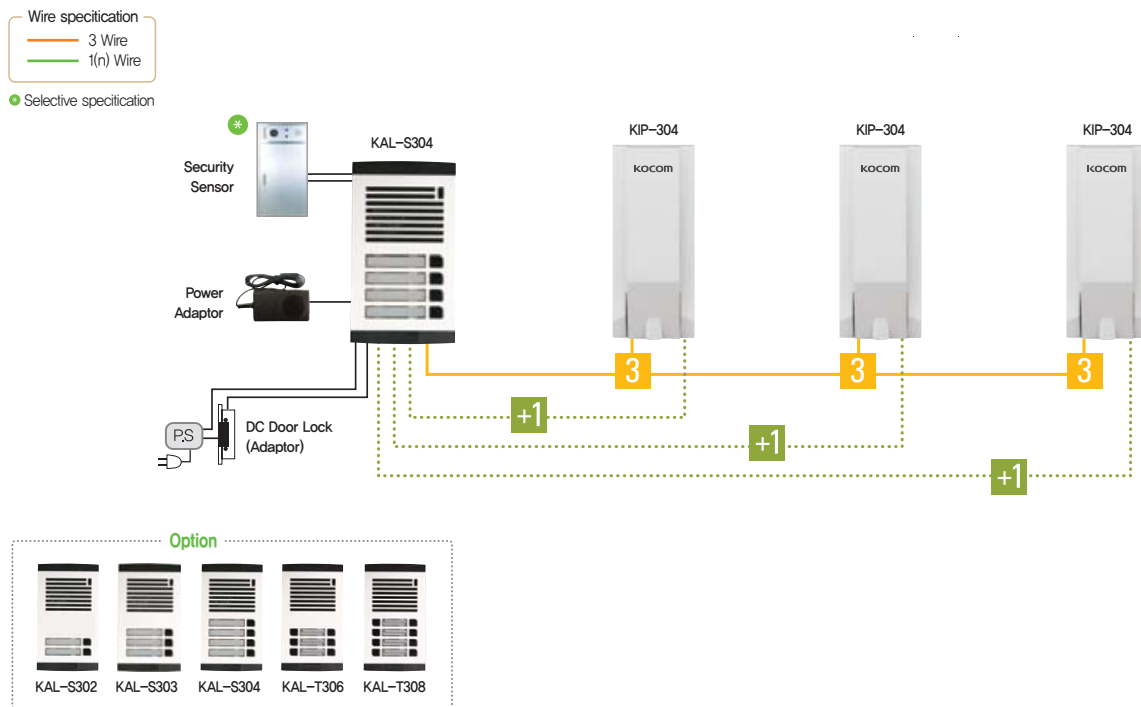

## KAL Series

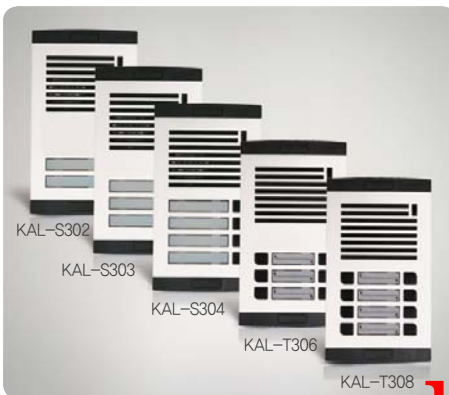

### Function

- Slim & Stylish Surface mount Type Audio Entrance Panel
- Call, Communication, and Door Open with Interphone (KIP-304)
- Clear & Loud Voice & convenient Voice Volume Control
- Up to 40 Household connections available
- Name Plate backlight (LED lamp)
- Safe Door Open function only when the communication is made
- Two door release Type (NO & NC) connection available
- Security Alarm Function (Security Sensor(not included) is needed)

### Specification

Installation	Surface Type
Speak Mode	Handsfree
Wiring	3 + (n) Wire
Power	DC 12V±1V
Surface Size	125(W) x 240(H) x 30(D)mm

[www.kocomhome.com](http://www.kocomhome.com)

## KIP-304



### Function

- Slim & Stylish Surface mount Type Audio Interphone
- Audio Communication with a Visitor
- Clear & Loud Voice
- Door Open (Common Gate) Function
- Easy Installation (3+n)
- For Multi Apartment, Condominium, Villa, Office, Bank and Hospital

### Specification

Installation	Surface Type
Speak Mode	Handset
Wiring	3 + 1 Wire(Polarity)
Power	DC 12V
Surface Size	75(W) x 176(H) x 52(D)mm

Home Network

Home Automation

Videophone

Door Camera

Digital Doorlock

Sub Device

Interphone

# Multiple Interphone & Doorphone

## KIP-612ML



### Function

- 12Ch Multiple Interphone
- Master (KIP-612ML) & Sub (IP-200PC) Phone System
- Gentle Electronic Sound
- Easy Wiring & Installation (Mount on the Wall or Desk)

### Specification

- Installation : Surface Type
- Speak Mode : Handset
- Wiring : 2 Wire
- Power : DC 24V, 1.2A
- Surface Size :
  - KIP-612ML : 92(W) x 210(H) x 57(D)mm
  - IP-200PC : 95(W) x 214(H) x 64(D)mm

## KIP-620ML



### Function

- 20Ch Multiple Interphone
- Master (KIP-620ML) & Sub (KIP-300) Phone system
- LED Indicator for All line
- Paging function to selected house.
- Easy Wiring & Installation (Terminal Box, Mount on the Wall or Desk)

### Specification

- Installation : Surface & desktop Type
- Speak Mode : Handset
- Wiring : 1+n Wire (Non-polarity)
- Power : DC 24V, 1A
- Surface Size : 175(W) X 175(H) X 55(D)mm

## KIP-300



### Function

- Sub unit for KIP-612ML/620ML
- Gentle Electronic sound
- Easy Installation (2 Wire)

### Specification

- Installation : Surface Type
- Speak Mode : Handset
- Wiring : 2 Wire
- Power : Powered from KIP-612ML/620ML
- Surface Size : 75(W) x 176(H) x 50(D)mm

## DS-2C



### Function

- Sub unit for KIP-612ML/620ML
- Gentle Electronic sound
- Easy Installation (2 Wire)

### Specification

- Installation : Surface Type
- Speak Mode : Handsfree
- Wiring : 2 Wire
- Power : Powered from KIP-612ML/620ML
- Surface Size : 75(W) x 176(H) x 50(D)mm

## Diagram

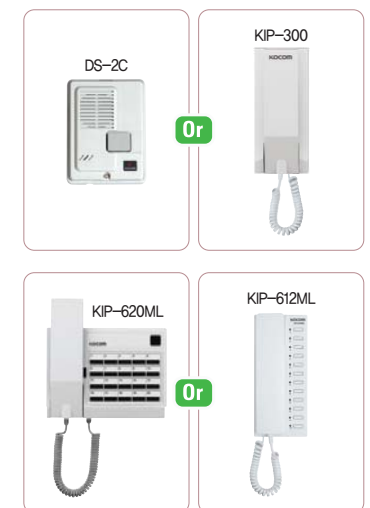
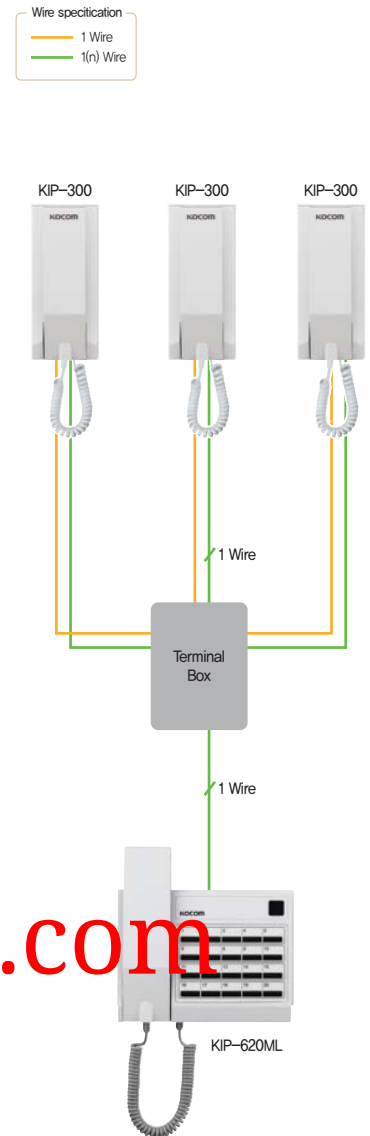



# Multiple Interphone & Doorphone

## KIP-605PG



### Function

- 5 Ch Multiple Interphone
- Single or Multiple Connection
- All Master Intercom System
- Paging Function
- Gentle Electronic Sound
- Easy Wiring & Installation (Mount on the Wall or Desk)
- Outdoor panel, DS-4M Connection \*option

### Specification

- Installation : Surface Type
- Speak Mode : Handset
- Wiring : 2 Wire
- Power : DC 24V, 1.2A
- Surface Size : 92(W) x 210(H) x 57(D)mm

## KIP-611PG



### Function

- 11 Ch Multiple Interphone and Doorphone
- Single or Multiple Connection
- All Master Intercom System
- Paging Function
- Gentle Electronic Sound
- Easy Wiring & Installation (Mount on the Wall or Desk)
- Outdoor panel, DS-4M Connection \*option

### Specification

- Installation : Surface Type
- Speak Mode : Handset
- Wiring : 2 Wire
- Power : DC 24V, 1.2A
- Surface Size : 92(W) x 210(H) x 57(D)mm

## Diagram

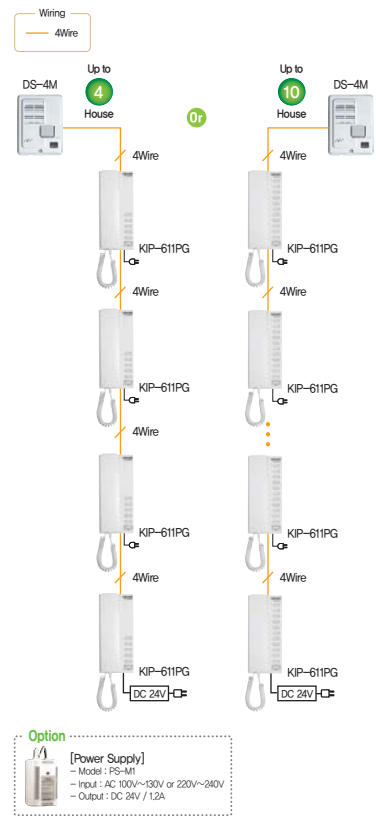

## DS-4M



### Function

- Single house outdoor pannel
- Call Household

### Specification

Installation	Surface Type
Speak Mode	Handsfree
Wiring	DS-4M : 4 Wire / DS-2D : 2 Wire
Power	Powered from audio handset
Surface Size	99(W) x 131(H) x 30(D)mm
Body Material	Plastic

[www.kocomhome.com](http://www.kocomhome.com)

Home Network

Home Automation

Videophone

Door Camera

Digital Doorlock

Sub Device

Interphone

## Duplex Interphone

### IP-201P



#### Function

- Duplex Interphone
- Gentle Electronic Sound
- Easy Wiring & Installation (Mount on the Wall or Desk)

#### Specification

- Installation : Surface Type
- Speak Mode : Handset
- Wiring : 2 Wire
- Power : DC 6V(AA 1.5V battery) x 4ea
- Surface Size : 95(W) x 214(H) x 64(D)mm

#### Diagram

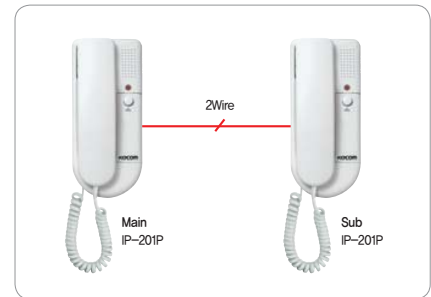

### KIP-501P



#### Function

- Duplex Interphone
- Gentle Electronic Sound
- Easy Wiring & Installation (Wall mount or Desk)

#### Specification

- Installation : Surface Type
- Speak Mode : Handset
- Wiring : 2 Wire
- Power : DC 6V(AA 1.5V battery) x 4ea
- Surface Size : 95(W) x 214(H) x 64(D)mm

#### Diagram

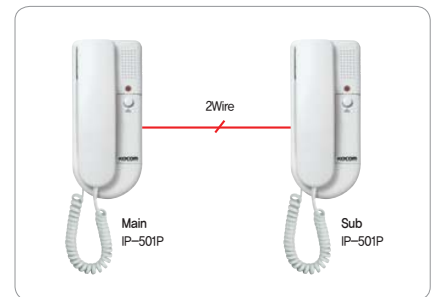

[www.kocomhome.com](http://www.kocomhome.com)

### KIP-601P



#### Function

- Duplex Interphone
- Gentle Electronic Sound
- Easy Wiring & Installation (Mount on the Wall or Desk)

#### Specification

- Installation : Surface Type
- Speak Mode : Handset
- Wiring : 2 Wire
- Power : DC 6V(AA 1.5V battery) x 4ea
- Surface Size : 92(W) x 210(H) x 57(D)mm

#### Diagram

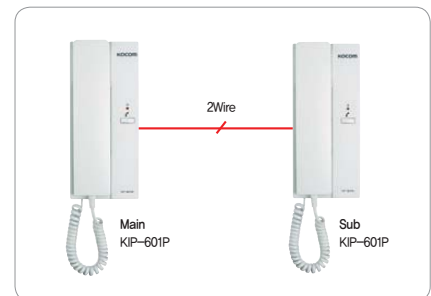

## Wireless Interphone

### KWI-2000L



#### Function

- Communication between operated locations on the same power transformer

#### Specification

- Installation : Surface Type
- Speak Mode : Handset
- Wiring : 2 Wire
- Power : AC 220V, 50/60Hz
- Surface Size : 98(W) x 203(H) x 70(D)mm

#### Diagram



# Intercom

## Intercom System Diagram

Wire specification  
— 2 Wire

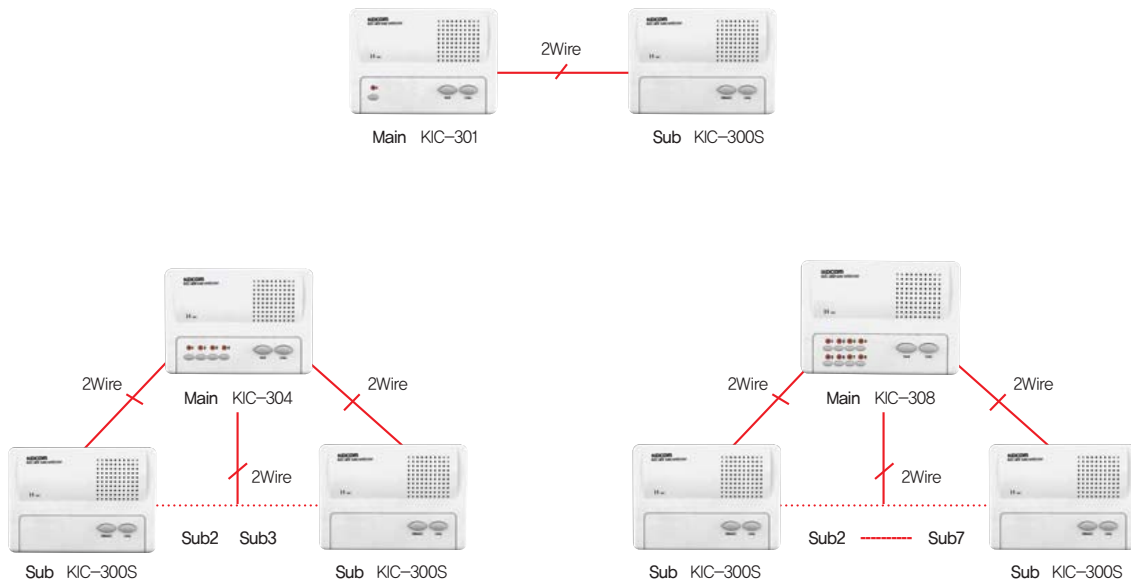

### KIC-308(8CH) / KIC-304(4CH) / KIC-301(1CH)

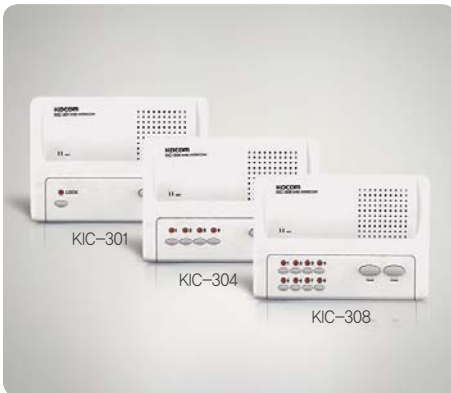

#### Function

- Perfect Communication
- Delightful Signal Sound
- LED Indicator for All line
- Easy Wiring & Installation (Wall mount or Desk)
- Power Indicator and Signal Volume

#### Specification

Speak Mode	Handsfree
Wiring	2 Wire(Polarity)
Power	DC 6V
Surface Size	272(W) x 125(H) x 42(D)mm

[www.kocomhome.com](http://www.kocomhome.com)



#### Function

- Sub Intercom for KIC-301, KIC-304 and KIC-308

#### Specification

Speak Mode	Handsfree
Wiring	2 Wire(Polarity)
Power	Powered from main unit
Surface Size	272(W) x 125(H) x 42(D)mm

Home Network

Home Automation

Videophone

Door Camera

Digital Doorlock

Sub Device

Interphone

## ASTRO Interphone

### ASTRO KIP-1T(AC) / ASTRO KIP-1TD(DC)



Main

Serve

#### Function

- Internal Call
- 2 Wire installation

#### Specification

Installation	Surface Type
Speak Mode	Handset
Communication Distance	100m used with 0,65 single cable
Wiring	2 Wire
Power	KIP-1T : AC 220V, 50/60Hz KIP-1TD : DC 6V(AA 1,5V x 4EA)
Surface Size	97,3(W) x 203,5(H) x 53,5(D)mm

### KIP-201P(AC) / KIP-201P(DC)



Main

Serve

#### Function

- One to one call & communication
- 2 Wire Installation

#### Specification

Installation	Surface Type
Speak Mode	Handset
Communication Distance	100m used with 0,65 single cable
Wiring	2 Wire
Power	KIP-201P(AC) : AC 220V, 50/60Hz KIP-201P(DC) : DC 6V(AA 1,5V x 4EA)
Surface Size	92(W) x 210(H) x 57(D)mm

### ASTRO KIP-6T / ASTRO KIP-11T



KIP-6TC

KIP-11TC

#### Function

- Mutual call up to 6~11 units
- Each interphone calls and talks to one another
- Sending a signal to the whole units

#### Specification

Installation	Surface Type
Speak Mode	Handset
Communication Distance	100m used with 0,65 single cable
Wiring	4 Wire(Bus Type)
Power	DC 24V(1,2A)
Surface Size	97,3(W) x 203,5(H) x 53,5(D)mm

### ASTRO KIP-12TM



#### Function

- Mutual call up to 12 interphones

#### Specification

Installation	Surface Type
Speak Mode	Handset
Wiring	2 Wire(Non-polarity) by sub-interphone
Power	DC 24V, 1,2A
Surface Size	97,3(W) x 203,5(H) x 53,5(D)mm

[www.kocomhome.com](http://www.kocomhome.com)



09121894870  
02136058926



[www.kocomhome.com](http://www.kocomhome.com)



**KOCOM** KOCOM CO.,LTD.

[www.kocom.com](http://www.kocom.com)

KOCOM BLDG., 22, Arayuk-ro, Gochon-eup, Gimpo-si,  
Gyeonggi-do, 415-816, Korea

TEL : +82-2-6675-2211 | FAX : +82-2-6675-2000

E-mail : [export@kocom.com](mailto:export@kocom.com)

Head Office



Factory Line



2015.11

※ This catalogue is based on the date as shown in the right and specifications are subject to change without notice for quality improvement.